



Product Series : GSTD	Brand : GOTREND
File Version : GSTD-SERIES-V6R1	Editor : Qiuyi Wu
Established Date : 2011.08.08	Description : High Current Inductor
Latest Edit Date : 2023.04.20	Product Type : <input checked="" type="checkbox"/> Standard <input type="checkbox"/> Customize

REMINDERS

- ◆ Product information in this catalog is subject to change without notice, and is for reference only. Therefore, please contact GOTREND Technology to check for the latest information before practical application or usage of the products.
- ◆ This catalog contains only typical specifications, please contact GOTREND Technology for further details if you can not find special components or information you need in this catalogue. Please also approve our product specifications or transact the approval sheet for product specifications before ordering.
- ◆ This catalogue only applies to products purchased through GOTREND Technology or its official agencies. This catalogue does not apply to products that are purchased through other third parties.
- ◆ Please read Attention and CAUTION note (for storage, operating, rating, soldering, mounting and handling) in this catalog to ensure product proper usage.
- ◆ GOTREND Technology is not responsible for issues that occur related to the intellectual property rights or other rights of our company or a third party when you use a product listed in this catalog. GOTREND Technology do not grant license of these rights.
- ◆ Information and data provided in the brochure can and do vary in different applications, and actual performance may vary over time.
- ◆ "Delivery Specification" illustrating precautions for the specifications and safety of each product listed in this catalog is available and we strongly recommend to provide these delivery specifications with customers that use these products.
- ◆ For exporting of product in this catalog, please take note it may be a restricted item according to the "Foreign Exchange and Foreign Trade Control Law". In such cases, it is necessary to acquire export permission in accordance to this law.
- ◆ Any reproduction or extraction of the contents in this catalog is prohibited without prior permission from GOTREND Technology.
- ◆ Products listed in this catalog are intended for general electronic device usage under normal operation and use condition including telecommunication equipment, home appliances, sports equipment AV equipment, industrial machine, office equipment etc. Please take note that our products are not designed, intended or authorized for use in below mentioned applications unless explicitly agreed in writing between the parties to avoid product failure that could result in situation where personal injury or death could occur.

- (1) Aerospace/Aviation equipment
- (2) Atomic energy-related equipment
- (3) Disaster prevention/crime prevention equipment
- (4) Electric heating apparatus, burning equipment
- (5) Medical equipment
- (6) Military equipment
- (7) Power-generation control equipment
- (8) Public information-processing equipment
- (9) Safety equipment
- (10) Seabed equipment
- (11) Transportation control equipment
- (12) Transportation equipment (cars, electric trains, ships, etc.)
- (13) Other applications that are not considered general-purpose applications

- ◆ Our manufacturing sites fully compliance with requirement regarding the quality management system in the automotive industry under the IATF 16949 standard. GOTREND Technology respect individual agreements with reference to customer requirements and customer specific requirements (CSR). We will like to emphasize that only requirements mutually agreed upon will in implemented in our Quality Management System taking into consideration that IATF 16949 may appear to support the acceptance of unilateral requirements. We will only legally bind to this individually agreed upon agreement under the IATF 16949 standard.
- ◆ The product itself is a powder metallurgy product, so the structure is relatively fragile, and it should not be used for products that are easy to fall. In addition, when this product is assembled, it should avoid collision with the tool or mechanism shell. 
- ◆ It is not recommended to use hot air gun for disassembling of this product. When using of hot air gun to repair other parts, please also take note that long time or high temperature exposure of this product will also damage the inductance device. If you need to use the hot air gun to disassemble the product, it is recommended to adjust the hot air gun temperature to 380 deg.C±5 deg.C. The blower head of the hot air gun should be perpendicular and at least 1cm away from the product. After heating the product to the tin material melting point, use tweezers to remove the product from the PCB. 

Product Series : GSTD	Brand : GOTREND
File Version : GSTD-SERIES-V6R1	Editor : Qiuyi Wu
Established Date : 2011.08.08	Description : High Current Inductor
Latest Edit Date : 2023.04.20	Product Type : <input checked="" type="checkbox"/> Standard <input type="checkbox"/> Customize

Features & Application :

- * High performance (Isat) realized by metal dust core.
- * Low loss realized with low DCR
- * Capable of corresponding high frequency
- * 100% lead (Pb) free meet RoHS standard
- * DC / DC converter for CPU in Notebook PC



(Picture for reference only)

Part No. Example :

PN	:	GSTD	6030	P	E	-	100	M
-----		-----	-----	---	---		----	---
ID	:	1	2	3	4		5	6
1	:	GOTREND Series : GSTD						
2	:	Type Size Code : 6030 = 7.4 x 6.6 x 3.0 mm						
3	:	P = Pb free < 1000 ppm						
4	:	[E] : Material Code						
5	:	[L] Value : Inductance 100 = 10.0 uH , Ex. 6R8 = 6.8 uH						
6	:	[L] Tolerance : M = +/-20%						

Basic Information :

Made in	China
Pin Foot	SMD
Shielding	Yes
J-STD-020	MSL Level 1
RoHS	Compliant
REACH	Compliant
Halogen	Free

Operating & Storage Condition :

- * Operating Temp -40 ~ +125 deg.C (Including self - temperature rise)
- * Storage Temp 1. -10 ~ +45 deg.C , 50 ~ 60% RH (Product with taping)
2. -40 ~ +125 deg.C (On board)
- * Storage Life Time 6 Month (Less than 40 deg.C and 60% RH)

Attention & Caution :

- * Keep out of Splashing water or salt water
- * Avoid Toxic Gas (Hydrogen sulfide, Sulfurous acid, Chlorine, Ammonia)
- * Avoid Vibrations or shocks which exceed the specified condition
- * Avoid Dew condense
- * Avoid Layout near the edge of PCB
- * Avoid Over flexure after SMT mounting & PCBA
- * Pin foot or SMD pad solderability: Pb free type is best within 6 months after delivery
- * Humidity sensitive , IPC/JEDEC J-STD-020 MSL if over Level 1, recommend bake 30mins@150 degree before PCBA
- * Caution for human life relative applications : PLS contact & consult with GOTREND team in design stage.



Test Condition :

- * Equipment HP4284A , HP42841A - L , Q , DCR , IDC
HP8753D Network analyzer - SRF
- * Standard Atmosphere Conditions:
Ambient Temperature 20 ± 15 deg.C
Humidity RH 65 ± 20%
- * If there may be any doubt on the test result ,
Measurement shall be made within the following limits:
Ambient Temperature 25 ± 5 deg.C
Humidity RH 75 ± 10%

Recommend IR Reflow Curve : GTX-IR-FILE001

Lead Free Solder : A = 217 deg.C , B = 245+/-5 deg.C
Time : C = 40 ~ 60 Sec.

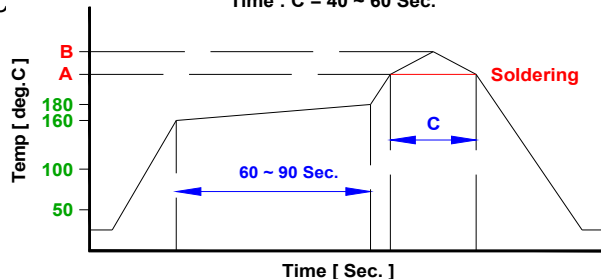

**Notice : Iron Soldering , Solder < 30 Watt ,
Direct touch the terminal x 3 Sec. Max. @ 350 deg.C**

Product Series : GSTD	Brand : GOTREND
File Version : GSTD-SERIES-V6R1	Editor : Qiuyi Wu
Established Date : 2011.08.08	Description : High Current Inductor
Latest Edit Date : 2023.04.20	Product Type : <input checked="" type="checkbox"/> Standard <input type="checkbox"/> Customize

SMD Power Inductor - GSTD Series Type

Image	Part Name	A (mm)	B (mm)	C (mm)	Inductance Range (uH)	DCR (m Ohm)	Isat (A)	Irms (A)	Page
	GSTD4012PJ	4.5	4.0	1.1	0.22 1.5	7.8-50.0	5.5-10.0	3.0-9.0	5
	GSTD4012PM	4.45	4.06	1.1	0.33 2.2	17.0-83.5	3.5-8.4	2.75-6.5	6
	GSTD4015PJ	4.5	4.0	1.4	0.22 2.2	6.4-56.4	4.5-11.0	3.0-9.5	7
	GSTD4020PE	4.5	4.0	1.8	0.1 10.0	3.5-282.0	2.2-22.0	1.2-12.0	8
	GSTD4020PJ	4.5	4.0	1.8	0.22 5.6	5.4-90.0	3.5-11.5	2.4-11.5	9
	GSTD5030PE	5.7	5.2	2.8	0.2 10.0	3.5-125.0	3.5-14.5	2.5-18.0	10
	GSTD6018PW	7.1	6.6	1.6	0.47 4.7	8.8-110.0	5.0-18.0	3.0-11.0	11
	GSTD6018PE	7.1	6.6	1.6	0.22 4.7	5.3-78.0	8.0-26.0	3.0-14.0	12
	GSTD6024PE	7.1	6.6	2.2	0.1 10.0	1.5-129.0	6.0-50.0	2.5-30.0	13
	GSTD6030PE	7.1	6.6	2.8	0.1 10.0	1.5-105.0	7.0-60.0	3.0-32.5	14
	GSTD6030PL	7.1	6.6	2.8	1.0 22.0	7.6-135.0	2.5-9.5	2.9-12.5	15
	GSTD6040PJ	7.6	6.6	4.0	0.22 15.0	2.0-60.0	4.3-34.0	3.6-23.0	16
	GSTD1040PE	11.5	10.5	3.8	0.19 10.0	0.88-36.5	12.0-90.0	6.8-40.0	17
	GSTD1040PL	11.5	10.5	3.8	0.19 100.0	0.7-270.0	2.25-46.0	3.0-40.0	18-19
	GSTD1050PJ	10.5	10.0	4.8	0.45 22.0	0.9-61.2	7.0-29.0	4.0-36.0	20
	GSTD1250PE	13.5	12.8	4.8	0.1 10.0	0.53-25.5	16.0-118.0	9.0-55.0	21-22
	GSTD1265PE	13.5	12.8	6.2	0.1 47.0	0.47-92.0	5.0-120.0	3.0-60.0	23-24

Product Series : GSTD	Brand : GOTREND
File Version : GSTD-SERIES-V6R1	Editor : Qiuyi Wu
Established Date : 2011.08.08	Description : High Current Inductor
Latest Edit Date : 2023.04.20	Product Type : <input checked="" type="checkbox"/> Standard <input type="checkbox"/> Customize

GSTD4012PJ-SERIES

Dimension [mm] :

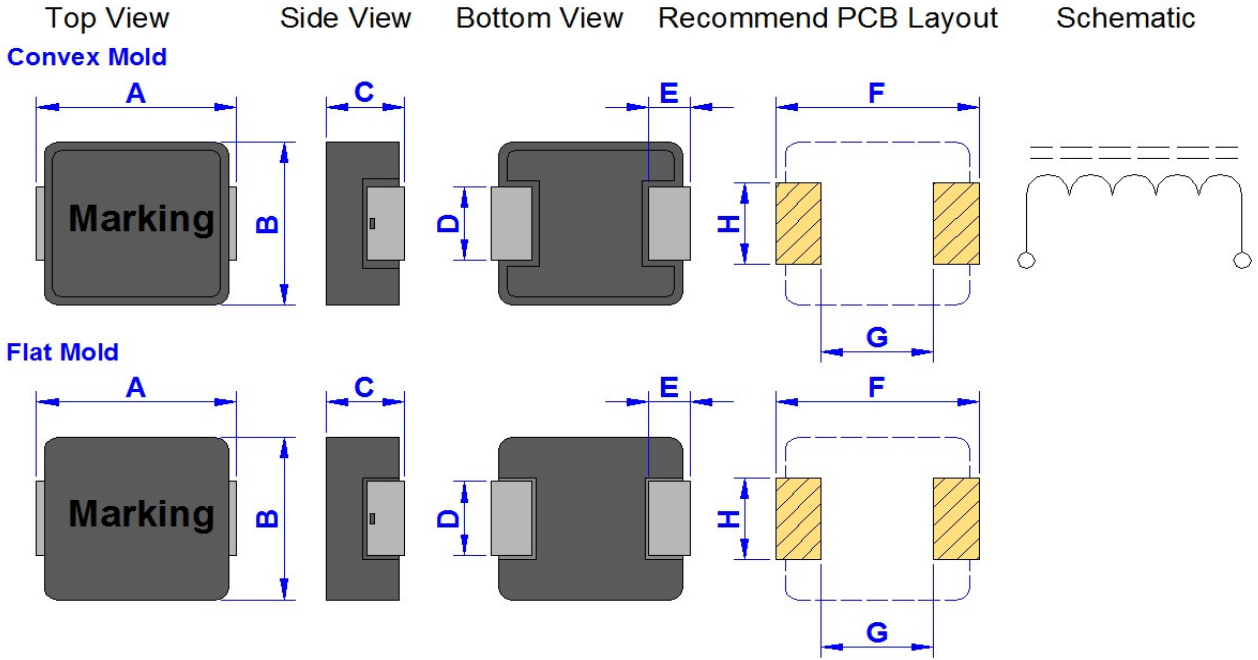

Size	A	B	C	D	E	F(Ref.)	G(Ref.)	H(Ref.)
4012PJ	4.50+/-0.20	4.00+/-0.20	1.10+/-0.10	BY ITEM	1.00+/-0.30	4.80	2.20	BY ITEM

Electrical Characteristics :

Part No.	Inductance (uH) +/-20%	DCR (m Ohm) Typ.	DCR (m Ohm) Max.	Isat (Amp) Typ.	Irms (Amp) Typ.	Dimension "D" (mm)	Dimension "H" (mm) Ref.
GSTD4012PJ-R22M	0.22	7.80	9.30	10.00	9.00	0.6 +/- 0.1	1.5
GSTD4012PJ-R47M	0.47	16.50	20.00	9.00	6.50	0.6 +/- 0.1	1.5
GSTD4012PJ-R56M	0.56	22.00	25.00	8.00	5.50	0.6 +/- 0.1	1.5
GSTD4012PJ-R68M	0.68	18.80	20.68	8.00	5.40	0.6 +/- 0.1	1.5
GSTD4012PJ-1R0M	1.00	28.30	33.60	6.33	4.80	0.6 +/- 0.1	1.5
GSTD4012PJ-1R2M	1.20	41.00	45.00	6.00	3.00	0.6 +/- 0.1	1.5
GSTD4012PJ-1R5M	1.50	45.00	50.00	5.50	3.00	0.6 +/- 0.1	1.5

* Test Condition : @100KHz , 1.0Vrms , 25deg.C Ambient

* I_{rms} : Rated Current Loading when temperature rise approximately 40deg.C

* I_{sat} : Saturated Current measured at the point of L drop approximately 20%

Product Series : GSTD	Brand : GOTREND
File Version : GSTD-SERIES-V6R1	Editor : Qiuyi Wu
Established Date : 2011.08.08	Description : High Current Inductor
Latest Edit Date : 2023.04.20	Product Type : <input checked="" type="checkbox"/> Standard <input type="checkbox"/> Customize

GSTD4012PM-SERIES

Dimension [mm] :

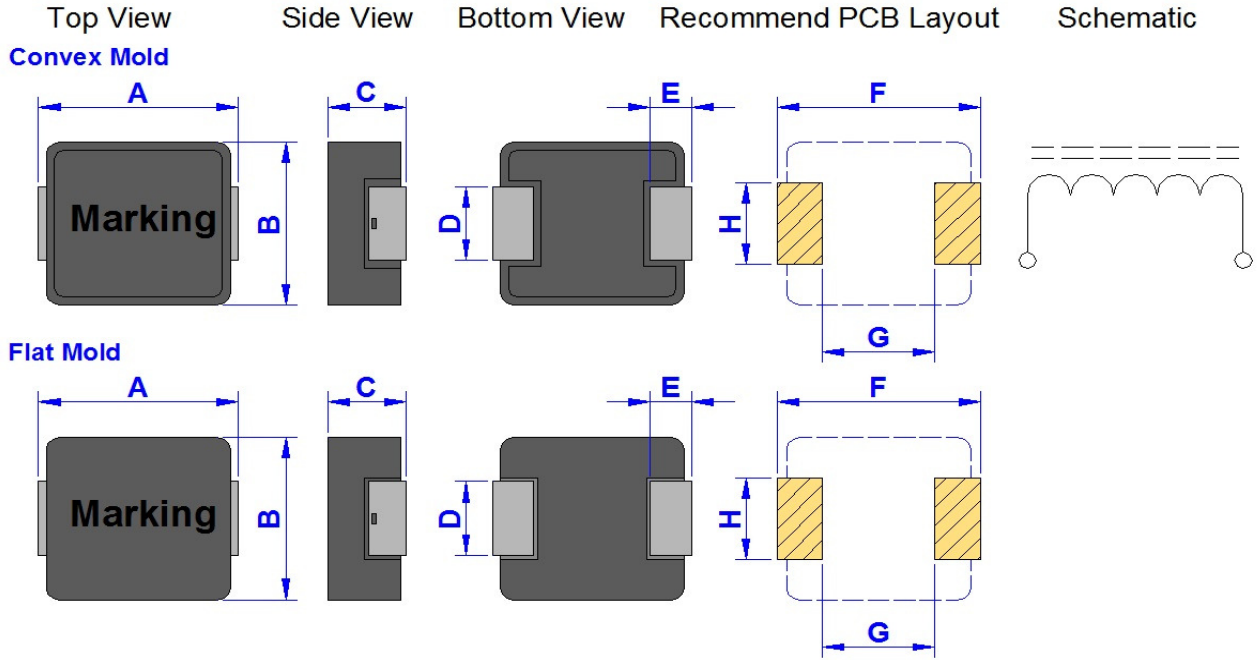

Size	A	B	C	D	E	F(Ref.)	G(Ref.)	H(Ref.)
4012PM	4.45 \pm 0.25	4.06 \pm 0.25	1.10 \pm 0.10	BY ITEM	0.76 \pm 0.30	4.80	2.20	BY ITEM

Electrical Characteristics :

Part No.	Inductance (uH) +/-20%	DCR (m Ohm) Typ.	DCR (m Ohm) Max.	Isat (Amp) Typ.	Irms (Amp) Typ.	Dimension "D" (mm)	Dimension "H" (mm) Ref.
GSTD4012PM-R33M	0.33	17.00	19.00	8.40	6.50	2.0 +/- 0.3	2.5
GSTD4012PM-R47M	0.47	19.00	21.00	6.80	6.00	2.0 +/- 0.3	2.5
GSTD4012PM-1R0M	1.00	43.00	47.00	5.20	4.20	2.0 +/- 0.3	2.5
GSTD4012PM-1R5M	1.50	68.00	75.00	4.00	3.25	2.0 +/- 0.3	2.5
GSTD4012PM-2R2M	2.20	79.40	83.50	3.50	2.75	2.0 +/- 0.3	2.5

* Test Condition : @100KHz , 1.0Vrms , 25deg.C Ambient

* I_{rms} : Rated Current Loading when temperature rise approximately 40deg.C

* I_{sat} : Saturated Current measured at the point of L drop approximately 30%

Product Series : GSTD	Brand : GOTREND
File Version : GSTD-SERIES-V6R1	Editor : Qiuyi Wu
Established Date : 2011.08.08	Description : High Current Inductor
Latest Edit Date : 2023.04.20	Product Type : <input checked="" type="checkbox"/> Standard <input type="checkbox"/> Customize

GSTD4015PJ-SERIES

Dimension [mm] :

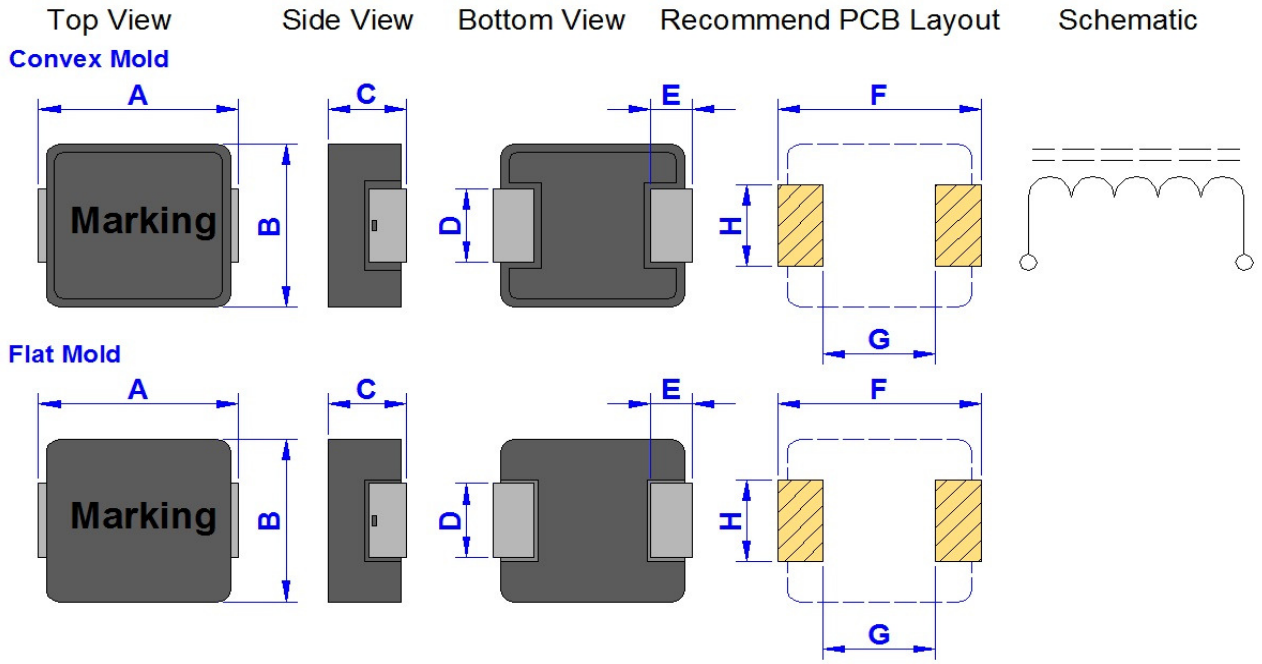

Size	A	B	C	D	E	F(Ref.)	G(Ref.)	H(Ref.)
4015PJ	4.50+/-0.20	4.00+/-0.20	1.40+/-0.10	BY ITEM	1.00+/-0.30	4.80	2.20	BY ITEM

Electrical Characteristics :

Part No.	Inductance (uH) +/-20%	DCR (m Ohm) Typ.	DCR (m Ohm) Max.	Isat (Amp) Typ.	Irms (Amp) Typ.	Dimension "D" (mm)	Dimension "H" (mm) Ref.
GSTD4015PJ-R22M	0.22	6.40	7.60	11.00	9.50	0.6 +/- 0.1	1.5
GSTD4015PJ-R47M	0.47	12.00	14.40	9.00	7.50	0.6 +/- 0.1	1.5
GSTD4015PJ-1R0M	1.00	23.50	27.00	7.00	5.00	0.6 +/- 0.1	1.5
GSTD4015PJ-1R2M	1.20	28.30	33.60	6.00	4.90	0.6 +/- 0.1	1.5
GSTD4015PJ-1R5M	1.50	32.00	38.40	6.00	4.00	0.6 +/- 0.1	1.5
GSTD4015PJ-2R2M	2.20	47.00	56.40	4.50	3.00	0.6 +/- 0.1	1.5

- * Test Condition : @100KHz , 1.0Vrms , 25deg.C Ambient
- * I_{rms} : Rated Current Loading when temperature rise approximately 40deg.C
- * I_{sat} : Saturated Current measured at the point of L drop approximately 20%

Product Series : GSTD	Brand : GOTREND
File Version : GSTD-SERIES-V6R1	Editor : Qiuyi Wu
Established Date : 2011.08.08	Description : High Current Inductor
Latest Edit Date : 2023.04.20	Product Type : <input checked="" type="checkbox"/> Standard <input type="checkbox"/> Customize

GSTD4020PE-SERIES

Dimension [mm] :

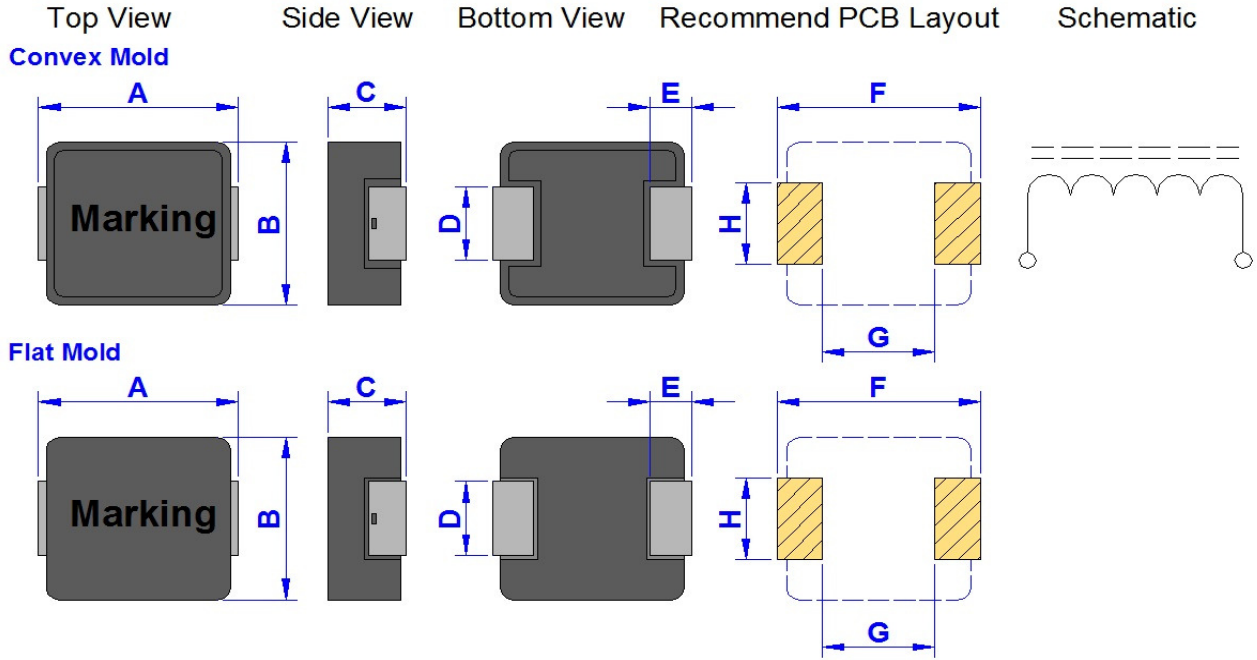

Size	A	B	C	D	E	F(Ref.)	G(Ref.)	H(Ref.)
4020PE	4.50+/-0.20	4.00+/-0.20	1.80+/-0.20	BY ITEM	0.76+/-0.30	4.80	2.20	BY ITEM

Electrical Characteristics :

Part No.	Inductance (uH) +/-20%	DCR (m Ohm) Typ.	DCR (m Ohm) Max.	Isat (Amp) Typ.	Irms (Amp) Typ.	Dimension "D" (mm)	Dimension "H" (mm) Ref.
GSTD4020PE-R10M	0.10	3.50	4.00	22.00	12.00	1.5 +/- 0.3	2.5
GSTD4020PE-R22M	0.22	6.00	6.60	12.50	9.00	1.5 +/- 0.3	2.5
GSTD4020PE-R47M	0.47	12.50	14.00	9.50	7.00	1.5 +/- 0.3	2.5
GSTD4020PE-R56M	0.56	14.00	16.00	10.00	6.50	1.5 +/- 0.3	2.5
GSTD4020PE-R68M	0.68	16.00	18.00	9.00	6.00	1.5 +/- 0.3	2.5
GSTD4020PE-1R0M	1.00	24.00	27.00	7.00	4.50	1.5 +/- 0.3	2.5
GSTD4020PE-1R2M	1.20	24.00	27.00	7.00	4.50	1.5 +/- 0.3	2.5
GSTD4020PE-1R5M	1.50	38.00	46.00	6.00	4.00	1.5 +/- 0.3	2.5
GSTD4020PE-2R2M	2.20	52.00	58.00	5.00	3.00	1.5 +/- 0.3	2.5
GSTD4020PE-3R3M	3.30	74.00	87.00	4.00	2.50	1.5 +/- 0.3	2.5
GSTD4020PE-4R7M	4.70	98.00	110.00	3.50	2.00	1.5 +/- 0.3	2.5
GSTD4020PE-6R8M	6.80	140.00	175.00	2.50	2.00	1.5 +/- 0.3	2.5
GSTD4020PE-100M	10.00	256.00	282.00	2.20	1.20	1.5 +/- 0.3	2.5

* Test Condition : @100KHz , 1.0Vrms , 25deg.C Ambient

* Irms : Rated Current Loading when temperature rise approximately 40deg.C

* Isat : Saturated Current measured at the point of L drop approximately 30%

Product Series : GSTD	Brand : GOTREND
File Version : GSTD-SERIES-V6R1	Editor : Qiuyi Wu
Established Date : 2011.08.08	Description : High Current Inductor
Latest Edit Date : 2023.04.20	Product Type : <input checked="" type="checkbox"/> Standard <input type="checkbox"/> Customize

GSTD4020PJ-SERIES

Dimension [mm] :

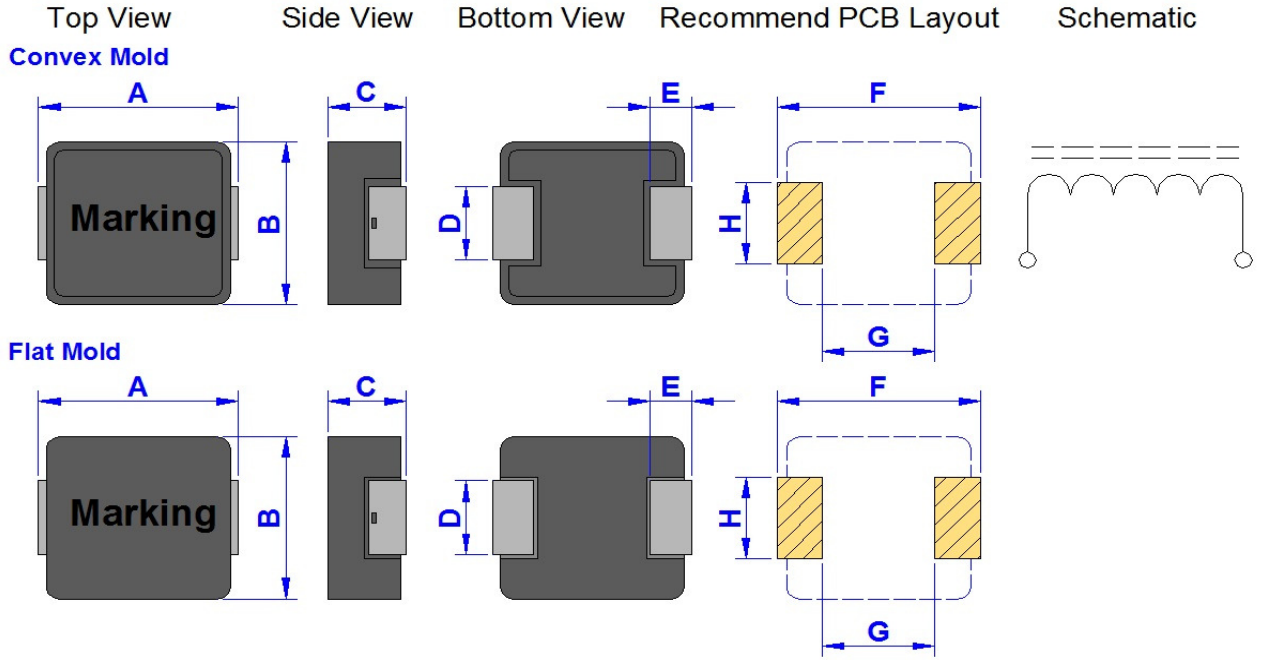

Size	A	B	C	D	E	F(Ref.)	G(Ref.)	H(Ref.)
4020PJ	4.50+/-0.20	4.00+/-0.20	1.80+/-0.20	BY ITEM	1.00+/-0.30	4.80	2.20	BY ITEM

Electrical Characteristics :

Part No.	Inductance (uH) +/-20%	DCR (m Ohm) Typ.	DCR (m Ohm) Max.	Isat (Amp) Typ.	Irms (Amp) Typ.	Dimension "D" (mm)	Dimension "H" (mm) Ref.
GSTD4020PJ-R22M	0.22	5.40	7.00	11.50	11.50	0.6 +/- 0.1	1.5
GSTD4020PJ-R36M	0.36	9.50	12.00	11.00	9.00	0.6 +/- 0.1	1.5
GSTD4020PJ-R47M	0.47	10.00	12.00	10.00	7.00	0.6 +/- 0.1	1.5
GSTD4020PJ-R56M	0.56	12.80	14.70	8.00	7.00	0.6 +/- 0.1	1.5
GSTD4020PJ-R68M	0.68	13.50	17.00	7.00	6.30	0.6 +/- 0.1	1.5
GSTD4020PJ-R82M	0.82	16.00	18.00	6.50	6.00	0.6 +/- 0.1	1.5
GSTD4020PJ-R88M	0.88	16.00	18.00	6.50	6.00	0.6 +/- 0.1	1.5
GSTD4020PJ-1R0M	1.00	18.00	21.50	5.00	5.00	0.6 +/- 0.1	1.5
GSTD4020PJ-1R2M	1.20	19.00	22.00	5.00	5.00	0.6 +/- 0.1	1.5
GSTD4020PJ-1R5M	1.50	25.40	29.00	5.00	5.00	0.6 +/- 0.1	1.5
GSTD4020PJ-2R2M	2.20	33.00	40.00	5.00	3.90	0.6 +/- 0.1	1.5
GSTD4020PJ-3R3M	3.30	42.00	48.00	4.30	3.30	0.6 +/- 0.1	1.5
GSTD4020PJ-4R7M	4.70	68.00	75.00	4.00	2.70	0.6 +/- 0.1	1.5
GSTD4020PJ-5R6M	5.60	81.00	90.00	3.50	2.40	0.6 +/- 0.1	1.5

* Test Condition : @100KHz , 1.0Vrms , 25deg.C Ambient

* I_{rms} : Rated Current Loading when temperature rise approximately 40deg.C

* I_{sat} : Saturated Current measured at the point of L drop approximately 20%

Product Series : GSTD	Brand : GOTREND
File Version : GSTD-SERIES-V6R1	Editor : Qiuyi Wu
Established Date : 2011.08.08	Description : High Current Inductor
Latest Edit Date : 2023.04.20	Product Type : <input checked="" type="checkbox"/> Standard <input type="checkbox"/> Customize

GSTD5030PE-SERIES

Dimension [mm] :

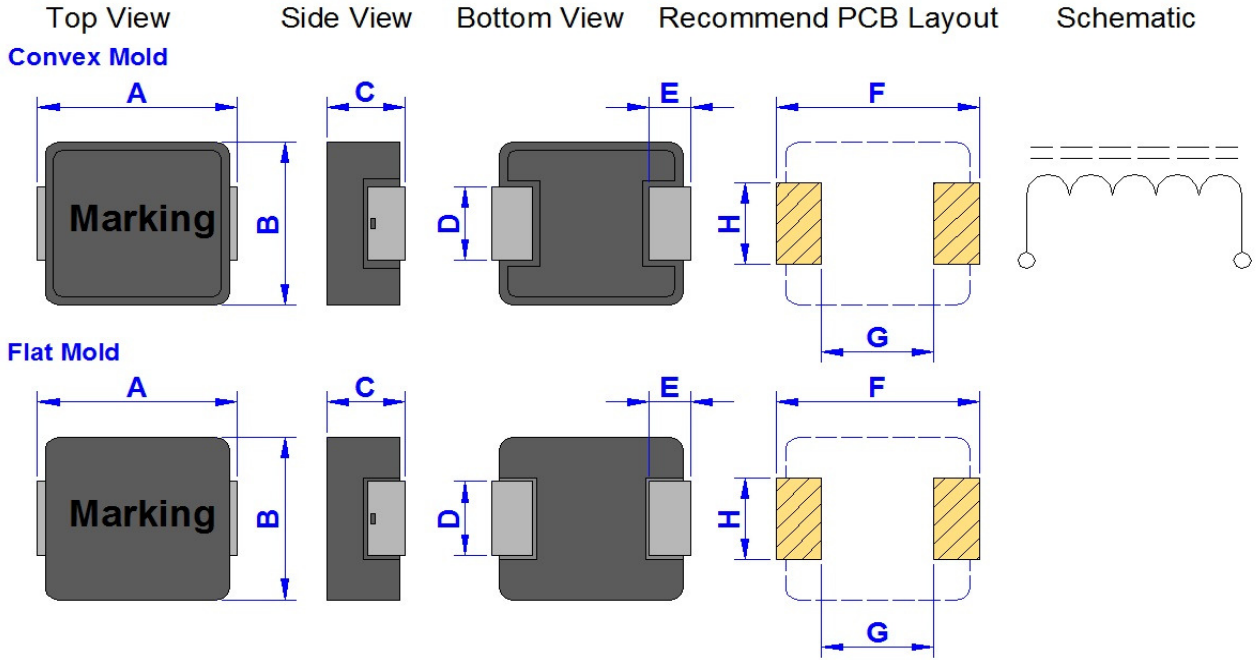

Size	A	B	C	D	E	F(Ref.)	G(Ref.)	H(Ref.)
5030PE	5.70+/-0.30	5.20+/-0.30	2.80+/-0.20	BY ITEM	1.30+/-0.30	5.70	2.00	BY ITEM

Electrical Characteristics :

Part No.	Inductance (uH) +/-20%	DCR (m Ohm) Typ.	DCR (m Ohm) Max.	Isat (Amp) Typ.	Irms (Amp) Typ.	Dimension "D" (mm)	Dimension "H" (mm) Ref.
GSTD5030PE-R20M	0.20	3.50	3.90	14.50	18.00	2.3 +/- 0.3	3.0
GSTD5030PE-R47M	0.47	7.40	8.50	12.00	13.50	2.3 +/- 0.3	3.0
GSTD5030PE-R68M	0.68	11.00	12.00	14.00	8.50	2.3 +/- 0.3	3.0
GSTD5030PE-1R0M	1.00	13.00	14.00	11.00	7.00	2.3 +/- 0.3	3.0
GSTD5030PE-1R2M	1.20	15.00	16.00	11.00	6.50	2.3 +/- 0.3	3.0
GSTD5030PE-1R5M	1.50	20.00	25.00	8.50	6.00	2.3 +/- 0.3	3.0
GSTD5030PE-2R2M	2.20	25.00	29.00	7.50	5.50	2.3 +/- 0.3	3.0
GSTD5030PE-3R3M	3.30	32.00	38.00	6.00	5.00	2.3 +/- 0.3	3.0
GSTD5030PE-4R7M	4.70	50.00	60.00	5.00	3.50	2.3 +/- 0.3	3.0
GSTD5030PE-6R8M	6.80	75.00	90.00	4.00	3.00	2.3 +/- 0.3	3.0
GSTD5030PE-100M	10.00	110.00	125.00	3.50	2.50	2.3 +/- 0.3	3.0

* Test Condition : @100KHz , 1.0Vrms , 25deg.C Ambient

* I_{rms} : Rated Current Loading when temperature rise approximately 40deg.C

* I_{sat} : Saturated Current measured at the point of L drop approximately 30%

Product Series : GSTD	Brand : GOTREND
File Version : GSTD-SERIES-V6R1	Editor : Qiuyi Wu
Established Date : 2011.08.08	Description : High Current Inductor
Latest Edit Date : 2023.04.20	Product Type : <input checked="" type="checkbox"/> Standard <input type="checkbox"/> Customize

GSTD6018PW-SERIES

Dimension [mm] :

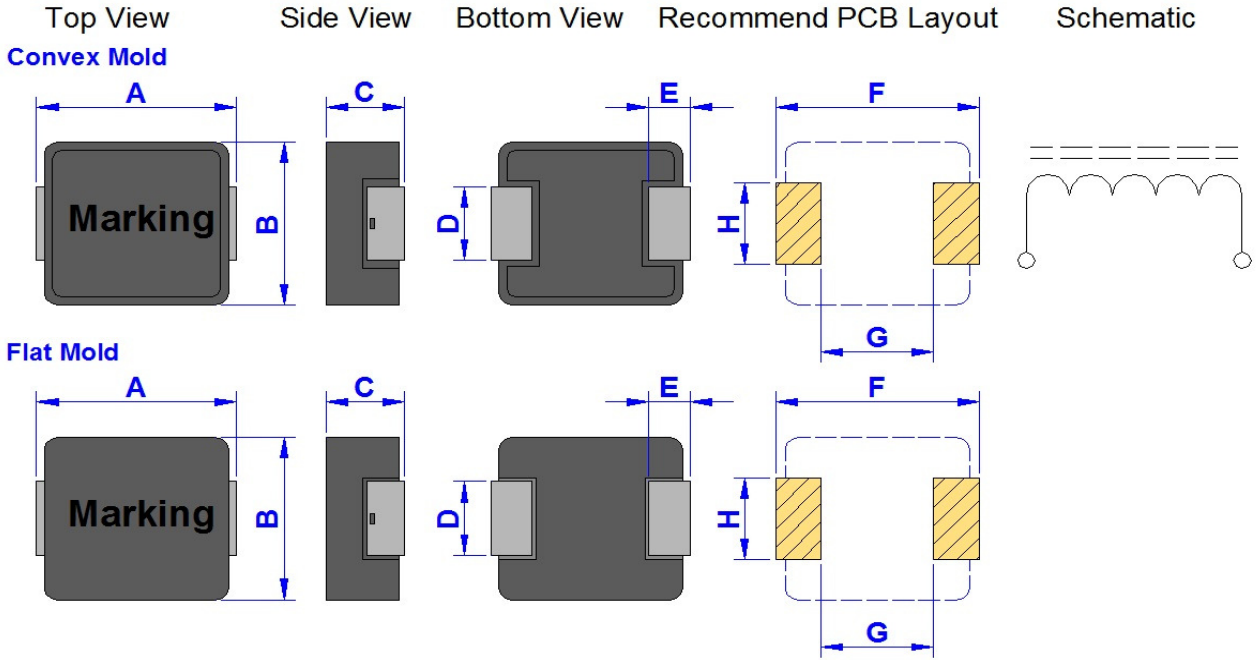

Size	A	B	C	D	E	F(Ref.)	G(Ref.)	H(Ref.)
6018PW	7.10+/-0.30	6.60+/-0.30	1.60+/-0.20	BY ITEM	1.60+/-0.50	7.40	3.70	BY ITEM

Electrical Characteristics :

Part No.	Inductance (uH) +/-20%	DCR (m Ohm) Typ.	DCR (m Ohm) Max.	Isat (Amp) Typ.	Irms (Amp) Typ.	Dimension "D" (mm)	Dimension "H" (mm) Ref.
GSTD6018PW-R47M	0.47	8.80	9.30	18.00	11.00	3.0 +/- 0.3	3.5
GSTD6018PW-1R0M	1.00	18.00	18.30	14.00	7.00	3.0 +/- 0.3	3.5
GSTD6018PW-1R5M	1.50	27.40	34.00	11.50	4.00	3.0 +/- 0.3	3.5
GSTD6018PW-2R2M	2.20	44.60	46.00	11.00	3.75	3.0 +/- 0.3	3.5
GSTD6018PW-3R3M	3.30	78.00	84.00	8.00	3.50	3.0 +/- 0.3	3.5
GSTD6018PW-4R7M	4.70	98.00	110.00	5.00	3.00	3.0 +/- 0.3	3.5

* Test Condition : @100KHz , 1.0Vrms , 25deg.C Ambient

* I_{rms} : Rated Current Loading when temperature rise approximately 40deg.C

* I_{sat} : Saturated Current measured at the point of L drop approximately 20%

Product Series : GSTD	Brand : GOTREND
File Version : GSTD-SERIES-V6R1	Editor : Qiuyi Wu
Established Date : 2011.08.08	Description : High Current Inductor
Latest Edit Date : 2023.04.20	Product Type : <input checked="" type="checkbox"/> Standard <input type="checkbox"/> Customize

GSTD6018PE-SERIES

Dimension [mm] :

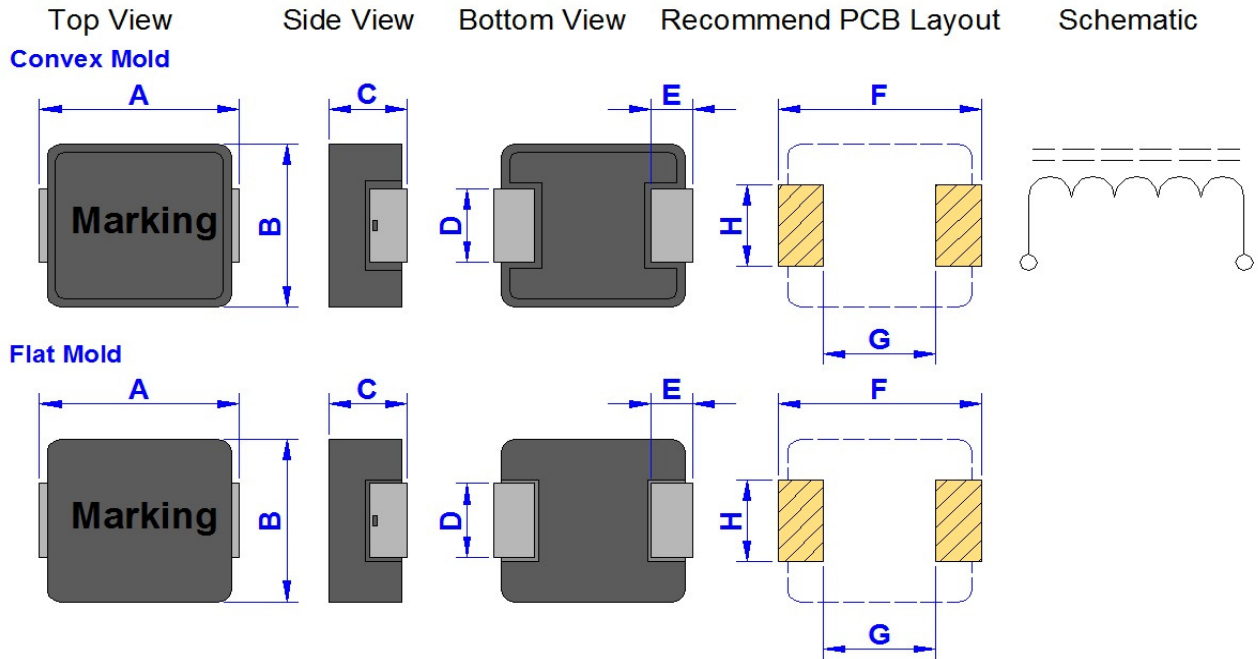

Size	A	B	C	D	E	F(Ref.)	G(Ref.)	H(Ref.)
6018PE	7.10+/-0.30	6.60+/-0.30	1.60+/-0.20	BY ITEM	1.60+/-0.50	7.40.	3.70	BY ITEM

Electrical Characteristics :

Part No.	Inductance (uH) +/-20%	DCR (m Ohm) Typ.	DCR (m Ohm) Max.	Isat (Amp) Typ.	Irms (Amp) Typ.	Dimension "D" (mm)	Dimension "H" (mm) Ref.
GSTD6018PE-R22M	0.22	5.30	5.70	26.00	14.00	3.0 +/- 0.3	3.5
GSTD6018PE-R33M	0.33	6.60	7.00	18.00	12.00	3.0 +/- 0.3	3.5
GSTD6018PE-R47M	0.47	8.40	9.30	18.00	11.00	3.0 +/- 0.3	3.5
GSTD6018PE-R68M	0.68	12.70	13.90	17.00	9.00	3.0 +/- 0.3	3.5
GSTD6018PE-R82M	0.82	13.80	15.90	17.00	8.00	3.0 +/- 0.3	3.5
GSTD6018PE-1R0M	1.00	17.50	18.30	14.00	7.00	3.0 +/- 0.3	3.5
GSTD6018PE-1R5M	1.50	32.60	34.00	11.50	4.00	3.0 +/- 0.3	3.5
GSTD6018PE-2R2M	2.20	40.30	46.00	11.00	3.75	3.0 +/- 0.3	3.5
GSTD6018PE-2R5M	2.50	49.90	52.40	10.40	3.50	3.0 +/- 0.3	3.5
GSTD6018PE-3R3M	3.30	56.20	60.10	10.00	3.25	3.0 +/- 0.3	3.5
GSTD6018PE-4R7M	4.70	76.00	78.00	8.00	3.00	3.0 +/- 0.3	3.5

* Test Condition : @100KHz , 1.0Vrms , 25deg.C Ambient

* Irms : Rated Current Loading when temperature rise approximately 40deg.C

* Isat : Saturated Current measured at the point of L drop approximately 30%

Product Series : GSTD	Brand : GOTREND
File Version : GSTD-SERIES-V6R1	Editor : Qiuyi Wu
Established Date : 2011.08.08	Description : High Current Inductor
Latest Edit Date : 2023.04.20	Product Type : <input checked="" type="checkbox"/> Standard <input type="checkbox"/> Customize

GSTD6024PE-SERIES

Dimension [mm] :

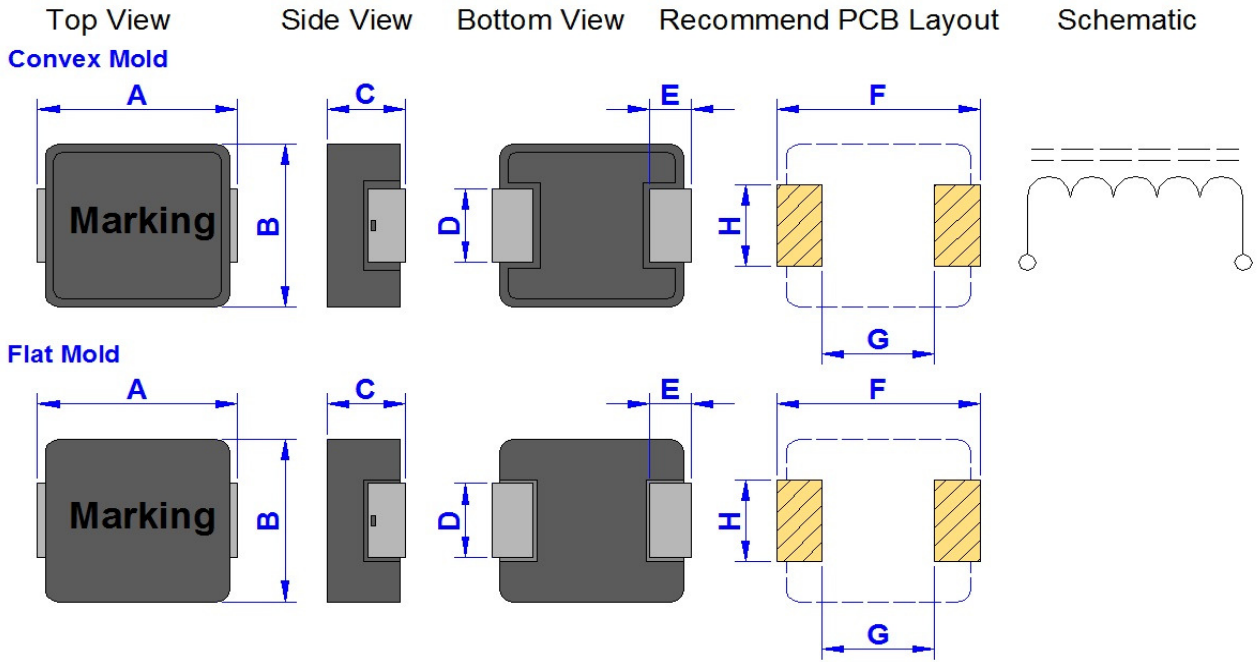

Size	A	B	C	D	E	F(Ref.)	G(Ref.)	H(Ref.)
6024PE	7.10+/-0.30	6.60+/-0.30	2.20+/-0.20	BY ITEM	1.60+/-0.50	7.40	3.70	BY ITEM

Electrical Characteristics :

Part No.	Inductance (uH) +/-20%	DCR (m Ohm) Typ.	DCR (m Ohm) Max.	Isat (Amp) Typ.	Irms (Amp) Typ.	Dimension "D" (mm)	Dimension "H" (mm) Ref.
GSTD6024PE-R10M	0.10	1.50	1.70	50.00	30.00	3.0 +/- 0.3	3.5
GSTD6024PE-R22M	0.22	2.90	3.20	34.00	21.00	3.0 +/- 0.3	3.5
GSTD6024PE-R33M	0.33	3.70	4.10	22.00	18.00	3.0 +/- 0.3	3.5
GSTD6024PE-R47M	0.47	6.00	6.50	21.00	13.50	3.0 +/- 0.3	3.5
GSTD6024PE-R68M	0.68	8.70	9.40	18.00	11.00	3.0 +/- 0.3	3.5
GSTD6024PE-R82M	0.82	10.60	11.80	17.00	10.00	3.0 +/- 0.3	3.5
GSTD6024PE-1R0M	1.00	13.00	14.20	16.00	9.00	3.0 +/- 0.3	3.5
GSTD6024PE-1R5M	1.50	18.50	21.20	15.00	7.50	3.0 +/- 0.3	3.5
GSTD6024PE-2R2M	2.20	28.00	34.00	14.00	6.50	3.0 +/- 0.3	3.5
GSTD6024PE-3R3M	3.30	36.50	51.60	13.00	5.00	3.0 +/- 0.3	3.5
GSTD6024PE-4R7M	4.70	45.00	63.00	9.00	4.50	3.0 +/- 0.3	3.5
GSTD6024PE-5R6M	5.60	66.00	73.00	8.00	4.00	3.0 +/- 0.3	3.5
GSTD6024PE-6R8M	6.80	72.50	95.00	7.00	3.60	3.0 +/- 0.3	3.5
GSTD6024PE-8R2M	8.20	84.00	106.00	6.50	3.00	3.0 +/- 0.3	3.5
GSTD6024PE-100M	10.00	116.00	129.00	6.00	2.50	3.0 +/- 0.3	3.5

* Test Condition : @100KHz , 1.0Vrms , 25deg.C Ambient

* Irms : Rated Current Loading when temperature rise approximately 40deg.C

* Isat : Saturated Current measured at the point of L drop approximately 30%

Product Series : GSTD	Brand : GOTREND
File Version : GSTD-SERIES-V6R1	Editor : Qiuyi Wu
Established Date : 2011.08.08	Description : High Current Inductor
Latest Edit Date : 2023.04.20	Product Type : <input checked="" type="checkbox"/> Standard <input type="checkbox"/> Customize

GSTD6030PE-SERIES

Dimension [mm] :

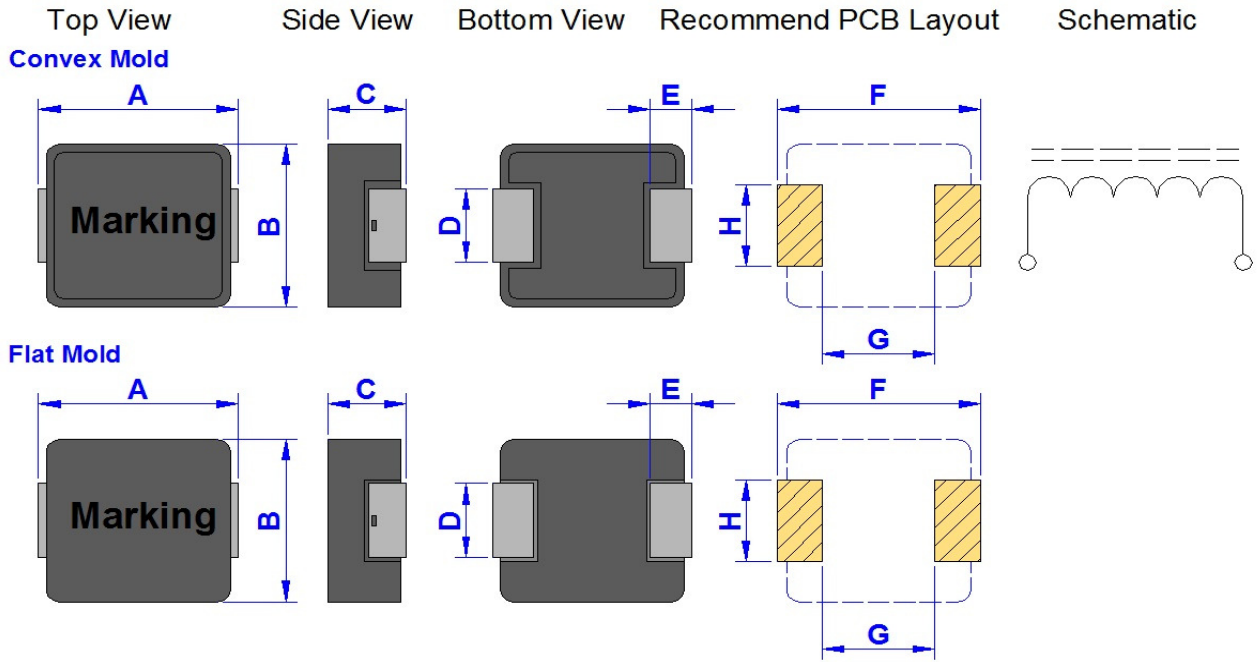

Size	A	B	C	D	E	F(Ref.)	G(Ref.)	H(Ref.)
6030PE	7.10+/-0.30	6.60+/-0.30	2.80+/-0.20	BY ITEM	1.60+/-0.50	7.40	3.70	BY ITEM

Electrical Characteristics :

Part No.	Inductance (uH) +/-20%	DCR (m Ohm) Typ.	DCR (m Ohm) Max.	Isat (Amp) Typ.	Irms (Amp) Typ.	Dimension "D" (mm)	Dimension "H" (mm) Ref.
GSTD6030PE-R10M	0.10	1.50	1.70	60.00	32.50	3.0 +/- 0.3	3.5
GSTD6030PE-R15M	0.15	1.90	2.50	52.00	26.00	3.0 +/- 0.3	3.5
GSTD6030PE-R20M	0.20	2.40	3.00	41.00	24.00	3.0 +/- 0.3	3.5
GSTD6030PE-R22M	0.22	2.50	2.80	40.00	23.00	3.0 +/- 0.3	3.5
GSTD6030PE-R33M	0.33	3.50	3.90	30.00	20.00	3.0 +/- 0.3	3.5
GSTD6030PE-R47M	0.47	4.00	4.20	26.00	17.50	3.0 +/- 0.3	3.5
GSTD6030PE-R56M	0.56	5.00	5.50	25.00	15.50	3.0 +/- 0.3	3.5
GSTD6030PE-R68M	0.68	5.00	5.50	25.00	15.50	3.0 +/- 0.3	3.5
GSTD6030PE-R82M	0.82	6.70	8.00	24.00	13.00	3.0 +/- 0.3	3.5
GSTD6030PE-1R0M	1.00	9.00	10.00	22.00	11.00	3.0 +/- 0.3	3.5
GSTD6030PE-1R5M	1.50	14.00	15.00	18.00	9.00	3.0 +/- 0.3	3.5
GSTD6030PE-2R2M	2.20	18.00	20.00	14.00	8.00	3.0 +/- 0.3	3.5
GSTD6030PE-3R3M	3.30	28.00	30.00	13.50	6.00	3.0 +/- 0.3	3.5
GSTD6030PE-4R7M	4.70	37.00	40.00	10.00	5.50	3.0 +/- 0.3	3.5
GSTD6030PE-6R8M	6.80	54.00	60.00	8.00	4.50	3.0 +/- 0.3	3.5
GSTD6030PE-8R2M	8.20	64.00	68.00	7.50	4.00	3.0 +/- 0.3	3.5
GSTD6030PE-100M	10.00	102.00	105.00	7.00	3.00	3.0 +/- 0.3	3.5

* Test Condition : @100KHz , 1.0Vrms , 25deg.C Ambient

* I_{rms} : Rated Current Loading when temperature rise approximately 40deg.C

* I_{sat} : Saturated Current measured at the point of L drop approximately 30%

Product Series : GSTD	Brand : GOTREND
File Version : GSTD-SERIES-V6R1	Editor : Qiuyi Wu
Established Date : 2011.08.08	Description : High Current Inductor
Latest Edit Date : 2023.04.20	Product Type : <input checked="" type="checkbox"/> Standard <input type="checkbox"/> Customize

GSTD6030PL-SERIES

Dimension [mm] :

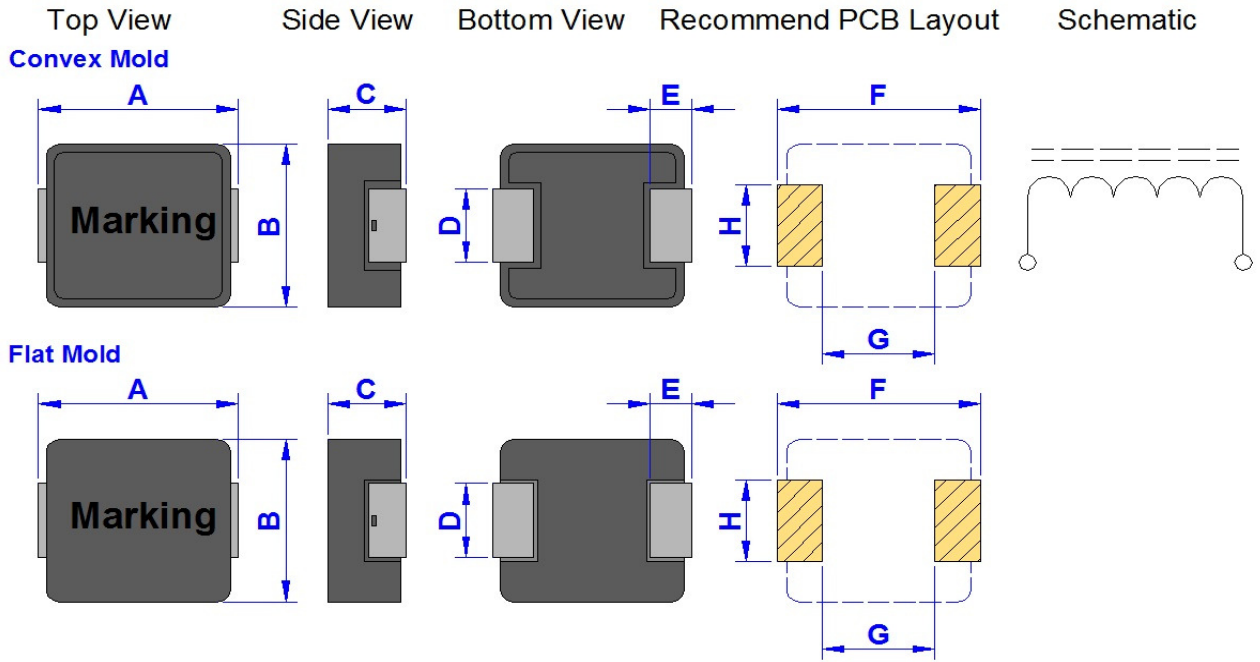

Size	A	B	C	D	E	F(Ref.)	G(Ref.)	H(Ref.)
6030PL	7.10+/-0.30	6.60+/-0.30	2.80+/-0.20	BY ITEM	1.60+/-0.50	7.40	3.70	BY ITEM

Electrical Characteristics :

Part No.	Inductance (uH) +/-20%	DCR (m Ohm) Typ.	DCR (m Ohm) Max.	Isat (Amp) Typ.	Irms (Amp) Typ.	Dimension "D" (mm)	Dimension "H" (mm) Ref.
GSTD6030PL-1R0M	1.00	7.60	8.00	9.50	12.50	3.0 +/- 0.3	3.5
GSTD6030PL-1R5M	1.50	11.70	12.50	8.00	10.50	3.0 +/- 0.3	3.5
GSTD6030PL-2R2M	2.20	15.70	16.50	7.00	9.00	3.0 +/- 0.3	3.5
GSTD6030PL-3R3M	3.30	24.80	26.00	6.50	7.00	3.0 +/- 0.3	3.5
GSTD6030PL-4R7M	4.70	31.80	33.40	4.00	6.00	3.0 +/- 0.3	3.5
GSTD6030PL-6R8M	6.80	44.60	46.80	4.00	5.50	3.0 +/- 0.3	3.5
GSTD6030PL-8R2M	8.20	52.30	54.90	4.00	5.00	3.0 +/- 0.3	3.5
GSTD6030PL-100M	10.00	67.80	71.20	3.50	4.00	3.0 +/- 0.3	3.5
GSTD6030PL-150M	15.00	110.00	125.00	3.00	3.50	3.0 +/- 0.3	3.5
GSTD6030PL-220M	22.00	128.90	135.00	2.50	2.90	3.0 +/- 0.3	3.5

* Test Condition : @100KHz , 1.0Vrms , 25deg.C Ambient

* I_{rms} : Rated Current Loading when temperature rise approximately 40deg.C

* I_{sat} : Saturated Current measured at the point of L drop approximately 30%

Product Series : GSTD	Brand : GOTREND
File Version : GSTD-SERIES-V6R1	Editor : Qiuyi Wu
Established Date : 2011.08.08	Description : High Current Inductor
Latest Edit Date : 2023.04.20	Product Type : <input checked="" type="checkbox"/> Standard <input type="checkbox"/> Customize

GSTD6040PJ-SERIES

Dimension [mm] :

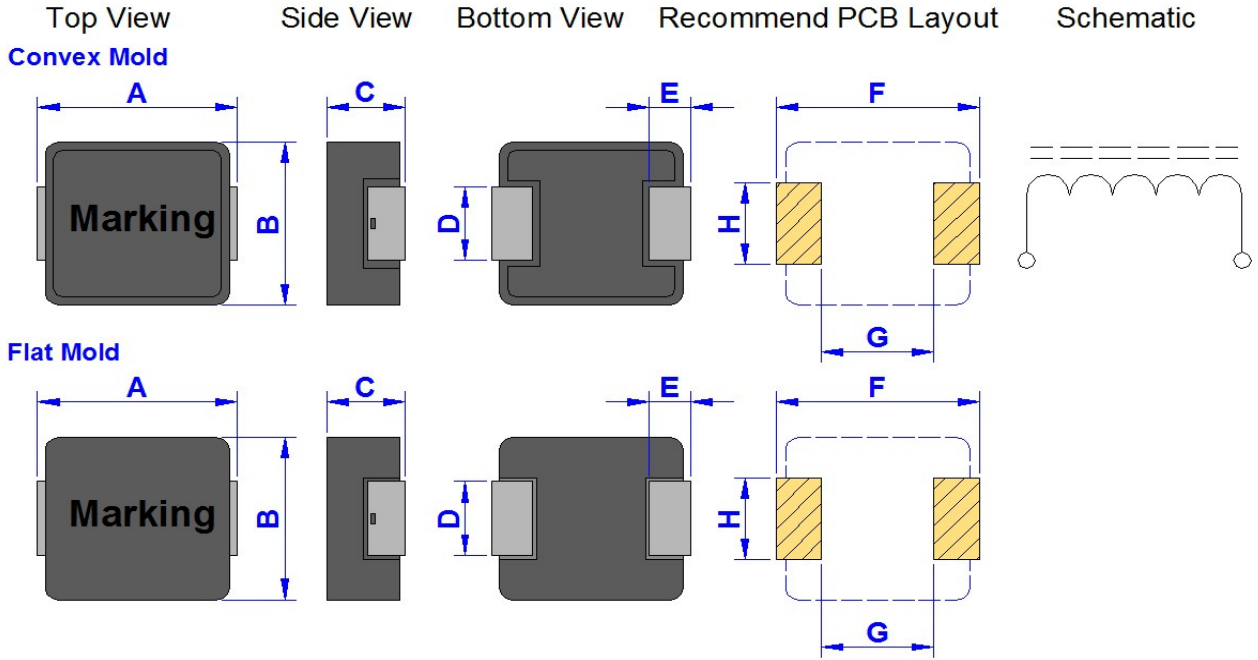

Size	A	B	C	D	E	F(Ref.)	G(Ref.)	H(Ref.)
6040PJ	7.60 Max.	6.60+/-0.30	4.00 Max.	BY ITEM	1.60+/-0.50	7.40	3.70	BY ITEM

Electrical Characteristics :

Part No.	Inductance (uH) +/-20%	DCR (m Ohm) Typ.	DCR (m Ohm) Max.	Isat (Amp) Typ.	Irms (Amp) Typ.	Dimension "D" (mm)	Dimension "H" (mm) Ref.
GSTD6040PJ-R22M	0.22	2.00	2.40	34.00	23.00	1.2 +/- 0.3	2.5
GSTD6040PJ-R33M	0.33	3.00	3.40	30.00	18.00	1.2 +/- 0.3	2.5
GSTD6040PJ-R36M	0.36	3.60	4.30	28.00	18.00	1.2 +/- 0.3	2.5
GSTD6040PJ-R47M	0.47	3.80	4.50	27.00	17.00	1.2 +/- 0.3	2.5
GSTD6040PJ-R50M	0.50	2.80	3.40	21.00	20.00	1.2 +/- 0.3	2.5
GSTD6040PJ-R56M	0.56	4.30	5.00	20.00	16.00	1.2 +/- 0.3	2.5
GSTD6040PJ-R68M	0.68	4.50	5.00	20.00	16.00	1.2 +/- 0.3	2.5
GSTD6040PJ-R82M	0.82	5.50	6.60	17.00	13.00	1.2 +/- 0.3	2.5
GSTD6040PJ-1R1M	1.10	4.60	5.50	19.00	15.30	1.2 +/- 0.3	2.5
GSTD6040PJ-1R5M	1.50	8.00	10.00	13.00	11.50	1.2 +/- 0.3	2.5
GSTD6040PJ-2R2M	2.20	9.80	12.00	11.00	11.00	1.2 +/- 0.3	2.5
GSTD6040PJ-3R3M	3.30	12.50	16.00	10.00	10.00	1.2 +/- 0.3	2.5
GSTD6040PJ-4R7M	4.70	18.40	24.00	8.00	6.70	1.2 +/- 0.3	2.5
GSTD6040PJ-5R6M	5.60	21.00	29.00	8.00	6.30	1.2 +/- 0.3	2.5
GSTD6040PJ-6R8M	6.80	29.00	33.00	7.00	6.00	1.2 +/- 0.3	2.5
GSTD6040PJ-8R2M	8.20	34.00	39.00	5.50	5.00	1.2 +/- 0.3	2.5
GSTD6040PJ-100M	10.00	42.50	45.00	5.00	4.10	1.2 +/- 0.3	2.5
GSTD6040PJ-120M	12.00	46.30	53.00	5.00	4.00	1.2 +/- 0.3	2.5
GSTD6040PJ-150M	15.00	57.30	60.00	4.30	3.60	1.2 +/- 0.3	2.5

* Test Condition : @100KHz , 1.0Vrms , 25deg.C Ambient

* I_{rms} : Rated Current Loading when temperature rise approximately 40deg.C

* I_{sat} : Saturated Current measured at the point of L drop approximately 20%

Product Series : GSTD	Brand : GOTREND
File Version : GSTD-SERIES-V6R1	Editor : Qiuyi Wu
Established Date : 2011.08.08	Description : High Current Inductor
Latest Edit Date : 2023.04.20	Product Type : <input checked="" type="checkbox"/> Standard <input type="checkbox"/> Customize

GSTD1040PE-SERIES

Dimension [mm] :

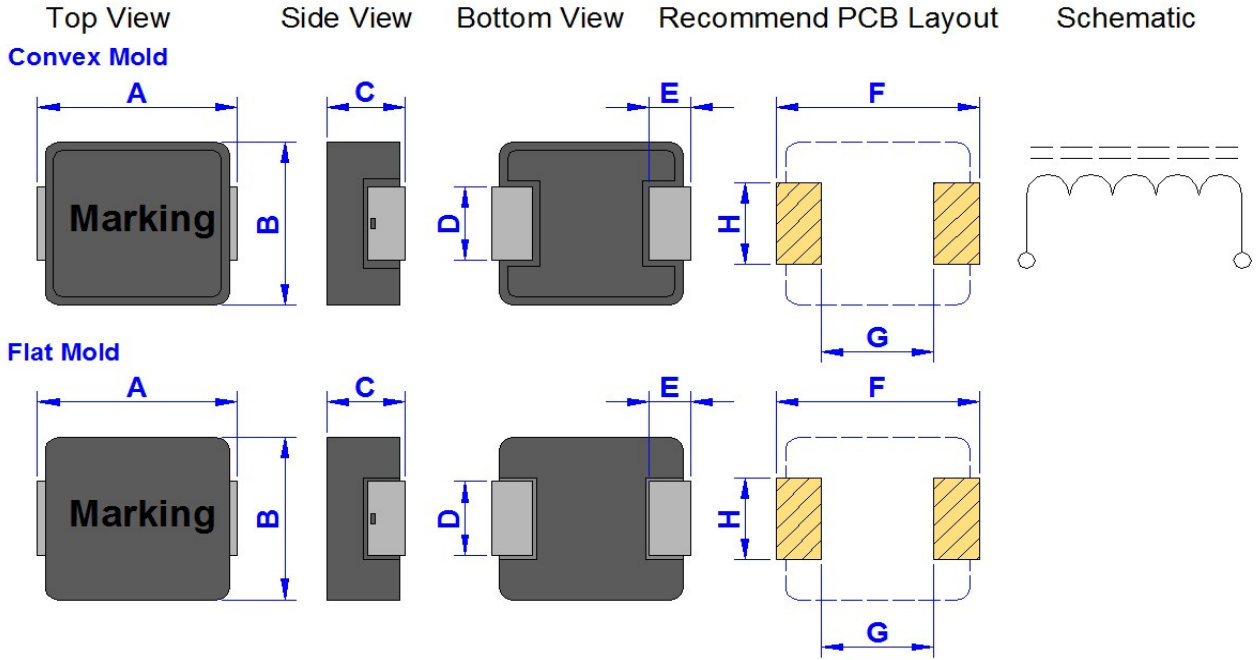

Size	A	B	C	D	E	F(Ref.)	G(Ref.)	H(Ref.)
1040PE	11.50+/-1.00	10.50+/-0.50	3.80+/-0.20	BY ITEM	2.50+/-0.50	13.00	6.00	BY ITEM

Electrical Characteristics :

Part No.	Inductance (uH) +/-20%	DCR (m Ohm) Typ.	DCR (m Ohm) Max.	Isat (Amp) Typ.	Irms (Amp) Typ.	Dimension "D" (mm)	Dimension "H" (mm) Ref.
GSTD1040PE-R19M	0.19	0.88	0.95	90.00	40.00	3.0 +/- 0.5	4.0
GSTD1040PE-R36M	0.36	1.30	1.40	60.00	31.50	3.0 +/- 0.5	4.0
GSTD1040PE-R56M	0.56	1.70	1.80	49.00	27.50	3.0 +/- 0.5	4.0
GSTD1040PE-1R0M	1.00	3.70	4.10	36.00	17.50	3.0 +/- 0.5	4.0
GSTD1040PE-1R5M	1.50	5.30	5.80	27.50	15.00	3.0 +/- 0.5	4.0
GSTD1040PE-2R2M	2.20	8.20	9.00	25.50	12.00	3.0 +/- 0.5	4.0
GSTD1040PE-3R3M	3.30	10.80	11.80	18.60	10.00	3.0 +/- 0.5	4.0
GSTD1040PE-4R7M	4.70	15.00	16.50	17.00	9.50	3.0 +/- 0.5	4.0
GSTD1040PE-5R6M	5.60	17.60	19.30	16.00	8.50	3.0 +/- 0.5	4.0
GSTD1040PE-6R8M	6.80	21.20	23.30	13.50	8.00	3.0 +/- 0.5	4.0
GSTD1040PE-8R2M	8.20	31.00	34.00	12.50	7.00	3.0 +/- 0.5	4.0
GSTD1040PE-100M	10.00	33.20	36.50	12.00	6.80	3.0 +/- 0.5	4.0

* Test Condition : @100KHz , 1.0Vrms , 25deg.C Ambient

* Irms : Rated Current Loading when temperature rise approximately 40deg.C

* Isat : Saturated Current measured at the point of L drop approximately 30%

Product Series : GSTD	Brand : GOTREND
File Version : GSTD-SERIES-V6R1	Editor : Qiuyi Wu
Established Date : 2011.08.08	Description : High Current Inductor
Latest Edit Date : 2023.04.20	Product Type : <input checked="" type="checkbox"/> Standard <input type="checkbox"/> Customize

GSTD1040PL-SERIES

Dimension [mm] :

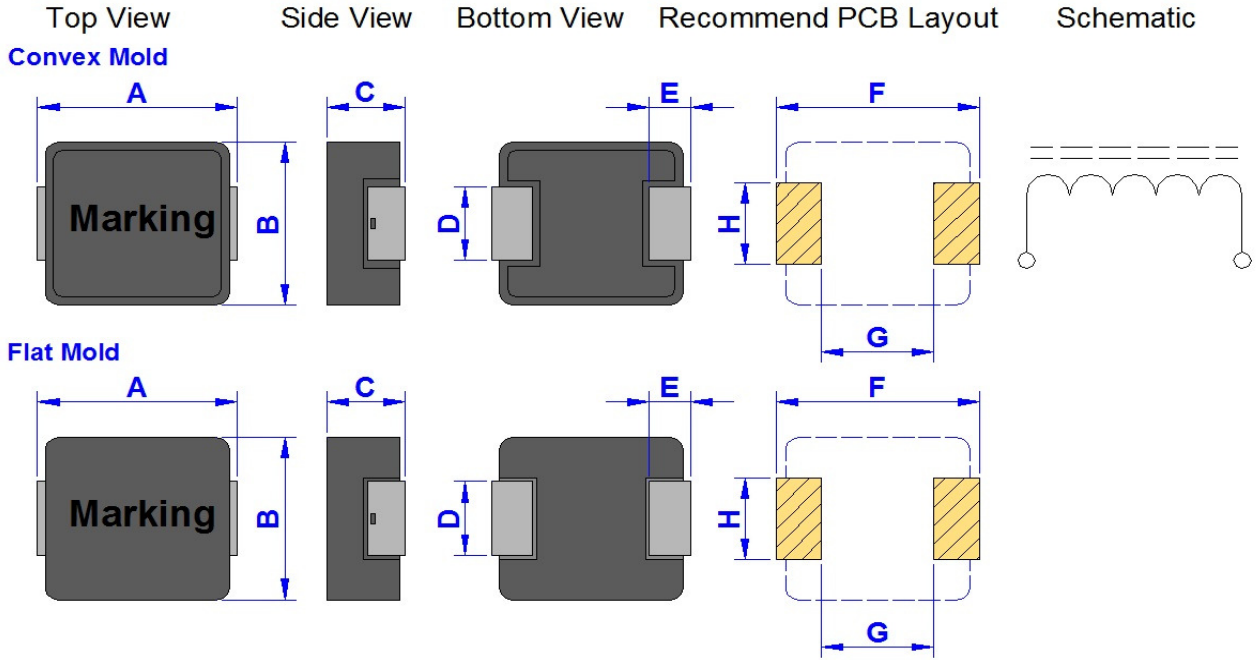

Size	A	B	C	D	E	F(Ref.)	G(Ref.)	H(Ref.)
1040PL	11.50+/-1.00	10.50+/-0.50	3.80+/-0.20	BY ITEM	2.50+/-0.50	13.00	6.00	BY ITEM

Electrical Characteristics :

Part No.	Inductance (uH) +/-20%	DCR (m Ohm) Typ.	DCR (m Ohm) Max.	Isat (Amp) Typ.	Irms (Amp) Typ.	Dimension "D" (mm)	Dimension "H" (mm) Ref.
GSTD1040PL-R19M	0.19	0.70	0.80	46.00	40.00	3.0 +/- 0.5	4.0
GSTD1040PL-R24M	0.24	0.85	0.95	44.00	33.00	3.0 +/- 0.5	4.0
GSTD1040PL-R36M	0.36	1.05	1.15	30.00	32.00	3.0 +/- 0.5	4.0
GSTD1040PL-R47M	0.47	1.53	1.68	30.00	30.00	3.0 +/- 0.5	4.0
GSTD1040PL-R56M	0.56	1.60	1.80	22.00	32.00	3.0 +/- 0.5	4.0
GSTD1040PL-R78M	0.78	1.80	1.90	22.00	27.00	3.0 +/- 0.5	4.0
GSTD1040PL-1R0M	1.00	2.30	2.50	20.00	25.00	3.0 +/- 0.5	4.0
GSTD1040PL-1R8M	1.80	4.50	5.00	16.00	17.00	3.0 +/- 0.5	4.0
GSTD1040PL-2R0M	2.00	5.20	5.80	14.00	16.00	3.0 +/- 0.5	4.0
GSTD1040PL-3R3M	3.30	8.20	9.00	14.00	12.00	3.0 +/- 0.5	4.0
GSTD1040PL-4R7M	4.70	12.90	14.20	7.60	9.50	3.0 +/- 0.5	4.0
GSTD1040PL-6R8M	6.80	17.50	19.30	7.50	9.00	3.0 +/- 0.5	4.0
GSTD1040PL-100M	10.00	27.80	30.50	7.10	7.50	3.0 +/- 0.5	4.0
GSTD1040PL-150M	15.00	40.90	45.00	6.00	6.25	3.0 +/- 0.5	4.0
GSTD1040PL-220M	22.00	60.40	66.00	4.50	5.00	3.0 +/- 0.5	4.0
GSTD1040PL-330M	33.00	87.50	94.50	4.00	4.40	3.0 +/- 0.5	4.0
GSTD1040PL-470M	47.00	132.00	145.00	3.00	4.00	3.0 +/- 0.5	4.0

* Test Condition : @100KHz , 1.0Vrms , 25deg.C Ambient

* I_{rms} : Rated Current Loading when temperature rise approximately 40deg.C

* I_{sat} : Saturated Current measured at the point of L drop approximately 30%

Product Series : GSTD	Brand : GOTREND
File Version : GSTD-SERIES-V6R1	Editor : Qiuyi Wu
Established Date : 2011.08.08	Description : High Current Inductor
Latest Edit Date : 2023.04.20	Product Type : <input checked="" type="checkbox"/> Standard <input type="checkbox"/> Customize

GSTD1040PL-SERIES

Dimension [mm] :

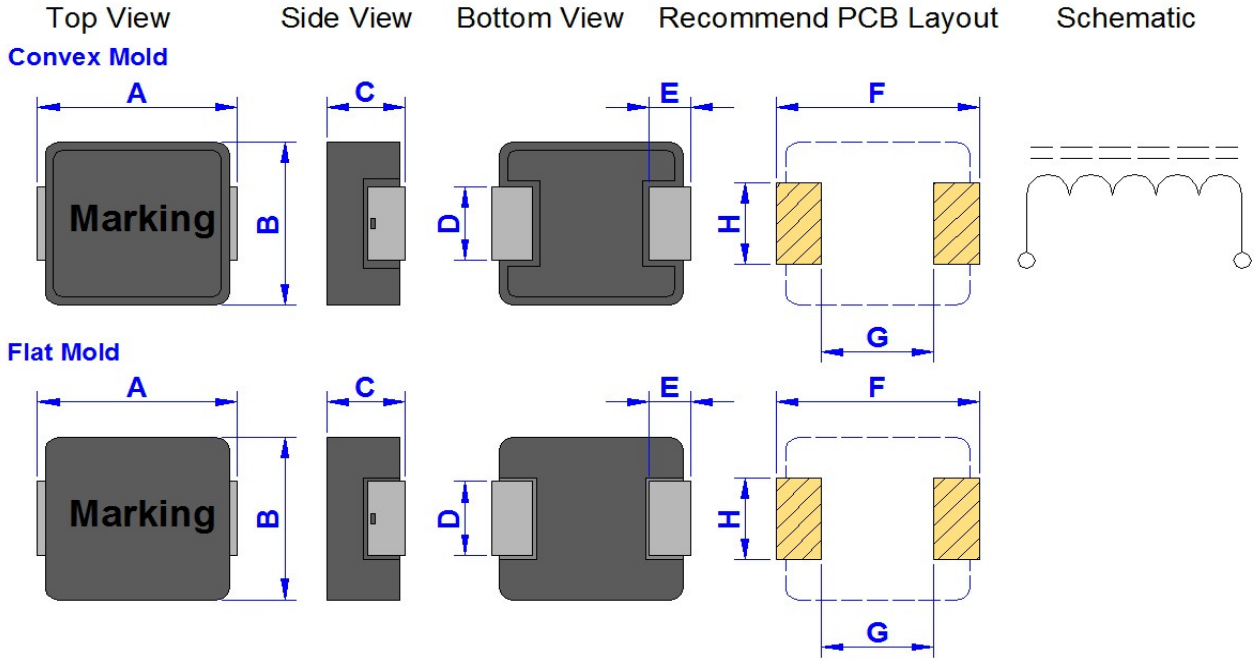

Size	A	B	C	D	E	F(Ref.)	G(Ref.)	H(Ref.)
1040PL	11.50+/-1.00	10.50+/-0.50	3.80+/-0.20	BY ITEM	2.50+/-0.50	13.00	6.00	BY ITEM

Electrical Characteristics :

Part No.	Inductance (uH) +/-20%	DCR (m Ohm) Typ.	DCR (m Ohm) Max.	Isat (Amp) Typ.	Irms (Amp) Typ.	Dimension "D" (mm)	Dimension "H" (mm) Ref.
GSTD1040PL-560M	56.00	150.00	170.00	2.80	3.80	3.0 +/- 0.5	4.0
GSTD1040PL-680M	68.00	175.00	200.00	2.60	3.50	3.0 +/- 0.5	4.0
GSTD1040PL-820M	82.00	210.00	240.00	2.40	3.20	3.0 +/- 0.5	4.0
GSTD1040PL-101M	100.00	249.00	270.00	2.25	3.00	3.0 +/- 0.5	4.0

* Test Condition : @100KHz , 1.0Vrms , 25deg.C Ambient

* I_{rms} : Rated Current Loading when temperature rise approximately 40deg.C

* I_{sat} : Saturated Current measured at the point of L drop approximately 30%

Product Series : GSTD	Brand : GOTREND
File Version : GSTD-SERIES-V6R1	Editor : Qiuyi Wu
Established Date : 2011.08.08	Description : High Current Inductor
Latest Edit Date : 2023.04.20	Product Type : <input checked="" type="checkbox"/> Standard <input type="checkbox"/> Customize

GSTD1050PJ-SERIES

Dimension [mm] :

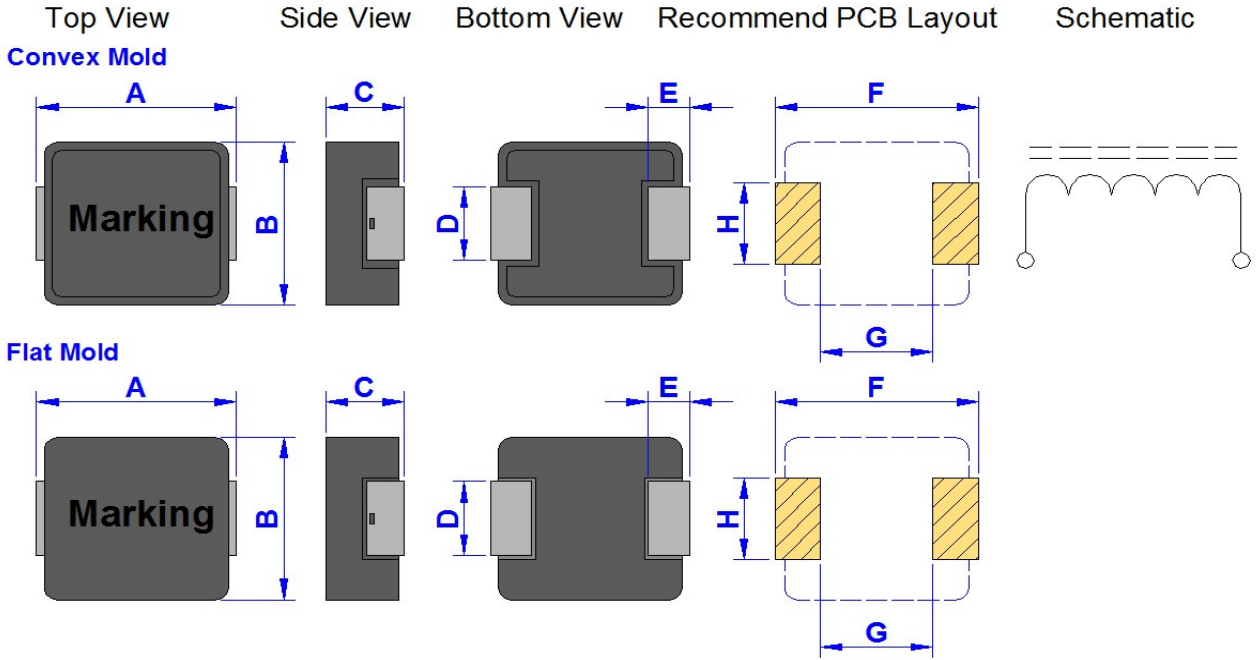

Size	A	B	C	D	E	F(Ref.)	G(Ref.)	H(Ref.)
1050PJ	10.50+/-1.00	10.00+/-0.30	4.80+/-0.20	BY ITEM	2.00+/-0.50	12.00	5.50	BY ITEM

Electrical Characteristics :

Part No.	Inductance (uH) +/-20%	DCR (m Ohm) Typ.	DCR (m Ohm) Max.	Isat (Amp) Typ.	Irms (Amp) Typ.	Dimension "D" (mm)	Dimension "H" (mm) Ref.
GSTD1050PJ-R45M	0.45	0.90	1.10	29.00	36.00	3.0 +/- 0.5	4.0
GSTD1050PJ-R56M	0.56	1.20	1.40	31.00	32.00	3.0 +/- 0.5	4.0
GSTD1050PJ-1R0M	1.00	2.30	2.50	25.00	25.00	3.0 +/- 0.5	4.0
GSTD1050PJ-1R2M	1.20	2.50	3.00	21.00	24.00	3.0 +/- 0.5	4.0
GSTD1050PJ-2R2M	2.20	5.30	6.30	19.00	14.00	3.0 +/- 0.5	4.0
GSTD1050PJ-4R7M	4.70	10.50	11.50	14.00	10.00	1.8 +/- 0.5	3.0
GSTD1050PJ-6R8M	6.80	13.50	15.50	11.00	9.00	3.0 +/- 0.5	4.0
GSTD1050PJ-100M	10.00	21.00	25.20	10.00	7.20	3.0 +/- 0.5	4.0
GSTD1050PJ-150M	15.00	38.00	45.60	8.00	4.50	1.8 +/- 0.5	3.0
GSTD1050PJ-220M	22.00	51.00	61.20	7.00	4.00	1.8 +/- 0.5	3.0

* Test Condition : @100KHz , 1.0Vrms , 25deg.C Ambient

* I_{rms} : Rated Current Loading when temperature rise approximately 40deg.C

* I_{sat} : Saturated Current measured at the point of L drop approximately 20%

Product Series : GSTD	Brand : GOTREND
File Version : GSTD-SERIES-V6R1	Editor : Qiuyi Wu
Established Date : 2011.08.08	Description : High Current Inductor
Latest Edit Date : 2023.04.20	Product Type : <input checked="" type="checkbox"/> Standard <input type="checkbox"/> Customize

GSTD1250PE-SERIES

Dimension [mm] :

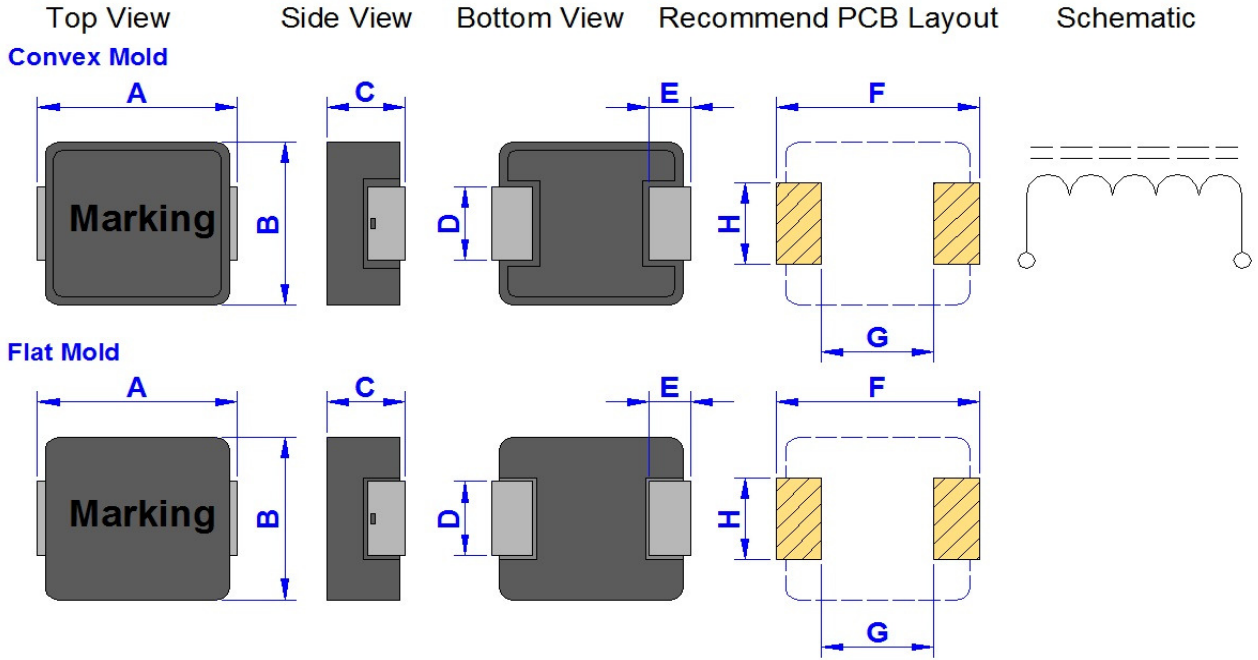

Size	A	B	C	D	E	F(Ref.)	G(Ref.)	H(Ref.)
1250PE	13.50+/-1.00	12.80+/-0.50	4.80+/-0.20	BY ITEM	2.50+/-0.50	15.00	6.00	BY ITEM

Electrical Characteristics :

Part No.	Inductance (uH) +/-20%	DCR (m Ohm) Typ.	DCR (m Ohm) Max.	Isat (Amp) Typ.	Irms (Amp) Typ.	Dimension "D" (mm)	Dimension "H" (mm) Ref.
GSTD1250PE-R10M	0.10	0.53	0.60	118.00	55.00	3.8 +/- 0.5	5.0
GSTD1250PE-R22M	0.22	0.64	0.80	110.00	51.00	3.8 +/- 0.5	5.0
GSTD1250PE-R33M	0.33	0.85	1.10	80.00	42.00	3.8 +/- 0.5	5.0
GSTD1250PE-R47M	0.47	1.10	1.30	65.00	38.00	3.8 +/- 0.5	5.0
GSTD1250PE-R56M	0.56	1.30	1.50	55.00	36.00	3.8 +/- 0.5	5.0
GSTD1250PE-R68M	0.68	1.50	1.70	54.00	34.00	3.8 +/- 0.5	5.0
GSTD1250PE-R82M	0.82	2.00	2.30	53.00	31.00	3.8 +/- 0.5	5.0
GSTD1250PE-1R0M	1.00	2.10	2.50	50.00	29.00	3.8 +/- 0.5	5.0
GSTD1250PE-1R2M	1.20	2.80	3.50	49.00	25.00	3.8 +/- 0.5	5.0
GSTD1250PE-1R5M	1.50	3.40	4.10	48.00	23.00	3.8 +/- 0.5	5.0
GSTD1250PE-1R8M	1.80	4.20	4.90	40.00	19.00	3.8 +/- 0.5	5.0
GSTD1250PE-2R2M	2.20	4.60	5.50	32.00	20.00	3.8 +/- 0.5	5.0
GSTD1250PE-3R3M	3.30	7.70	9.20	32.00	15.00	3.8 +/- 0.5	5.0
GSTD1250PE-4R7M	4.70	12.80	15.00	27.00	12.00	3.8 +/- 0.5	5.0
GSTD1250PE-5R6M	5.60	14.00	16.50	22.00	11.50	3.8 +/- 0.5	5.0
GSTD1250PE-6R8M	6.80	15.40	18.50	21.00	11.00	3.8 +/- 0.5	5.0

* Test Condition : @100KHz , 1.0Vrms , 25deg.C Ambient

* I_{rms} : Rated Current Loading when temperature rise approximately 40deg.C

* I_{sat} : Saturated Current measured at the point of L drop approximately 30%

Product Series : GSTD	Brand : GOTREND
File Version : GSTD-SERIES-V6R1	Editor : Qiuyi Wu
Established Date : 2011.08.08	Description : High Current Inductor
Latest Edit Date : 2023.04.20	Product Type : <input checked="" type="checkbox"/> Standard <input type="checkbox"/> Customize

GSTD1250PE-SERIES

Dimension [mm] :

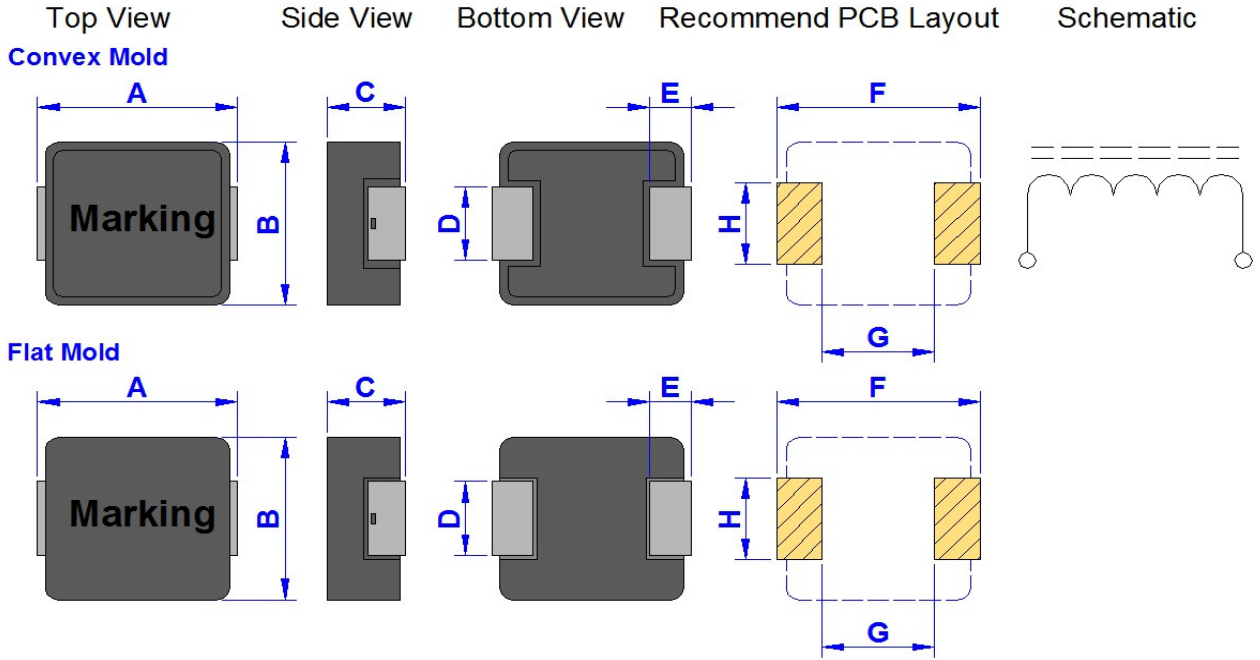

Size	A	B	C	D	E	F(Ref.)	G(Ref.)	H(Ref.)
1250PE	13.50+/-1.00	12.80+/-0.50	4.80+/-0.20	BY ITEM	2.50+/-0.50	15.00	6.00	BY ITEM

Electrical Characteristics :

Part No.	Inductance (uH) +/-20%	DCR (m Ohm) Typ.	DCR (m Ohm) Max.	Isat (Amp) Typ.	Irms (Amp) Typ.	Dimension "D" (mm)	Dimension "H" (mm) Ref.
GSTD1250PE-7R8M	7.80	17.20	20.50	18.00	10.00	3.8 +/- 0.5	5.0
GSTD1250PE-8R2M	8.20	18.90	22.50	18.00	9.50	3.8 +/- 0.5	5.0
GSTD1250PE-100M	10.00	21.40	25.50	16.00	9.00	3.8 +/- 0.5	5.0

* Test Condition : @100KHz , 1.0Vrms , 25deg.C Ambient

* Irms : Rated Current Loading when temperature rise approximately 40deg.C

* Isat : Saturated Current measured at the point of L drop approximately 30%

Product Series : GSTD	Brand : GOTREND
File Version : GSTD-SERIES-V6R1	Editor : Qiuyi Wu
Established Date : 2011.08.08	Description : High Current Inductor
Latest Edit Date : 2023.04.20	Product Type : <input checked="" type="checkbox"/> Standard <input type="checkbox"/> Customize

GSTD1265PE-SERIES

Dimension [mm] :

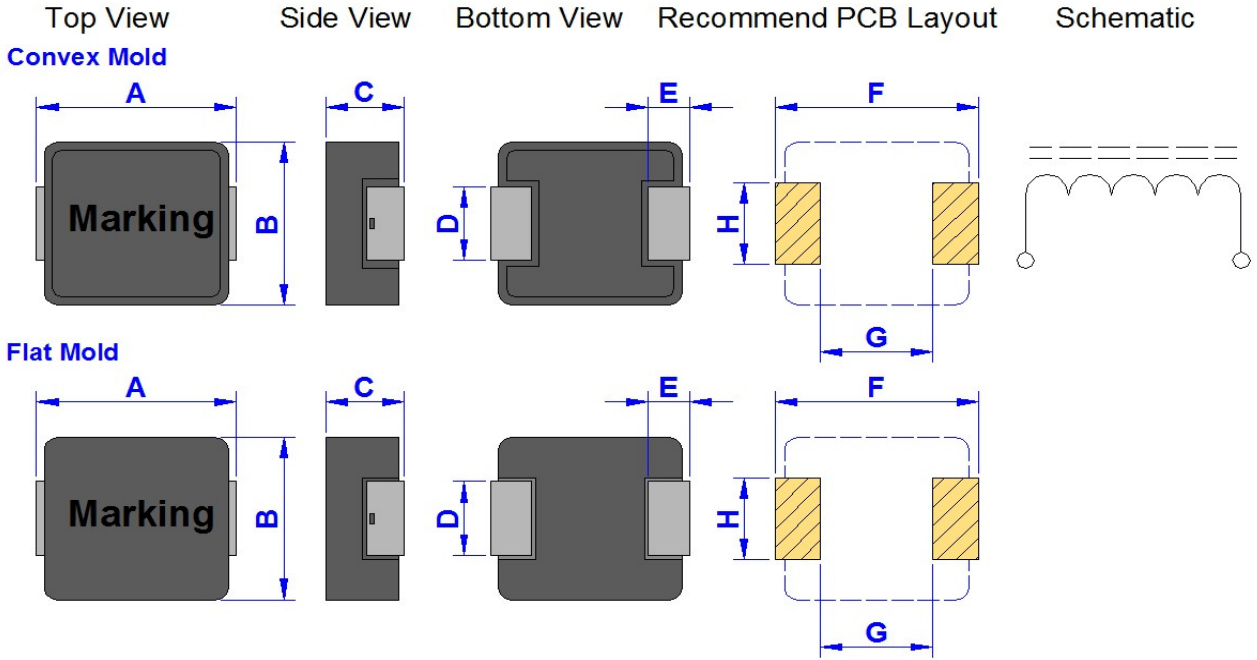

Size	A	B	C	D	E	F(Ref.)	G(Ref.)	H(Ref.)
1265PE	13.50+/-1.00	12.80+/-0.50	6.20+/-0.30	BY ITEM	2.50+/-0.50	15.00	6.00	BY ITEM

Electrical Characteristics :

Part No.	Inductance (uH) +/-20%	DCR (m Ohm) Typ.	DCR (m Ohm) Max.	Isat (Amp) Typ.	Irms (Amp) Typ.	Dimension "D" (mm)	Dimension "H" (mm) Ref.
GSTD1265PE-R10M	0.10	0.47	0.50	120.00	60.00	3.8 +/- 0.5	5.0
GSTD1265PE-R15M	0.15	0.53	0.60	118.00	55.00	3.8 +/- 0.5	5.0
GSTD1265PE-R22M	0.22	0.63	0.70	112.00	53.00	3.8 +/- 0.5	5.0
GSTD1265PE-R30M	0.30	0.70	0.80	72.00	48.00	3.8 +/- 0.5	5.0
GSTD1265PE-R33M	0.33	0.83	0.90	65.00	46.00	3.8 +/- 0.5	5.0
GSTD1265PE-R40M	0.40	0.90	1.00	64.00	44.00	3.8 +/- 0.5	5.0
GSTD1265PE-R47M	0.47	1.00	1.20	63.00	41.00	3.8 +/- 0.5	5.0
GSTD1265PE-R56M	0.56	1.20	1.40	62.00	37.00	3.8 +/- 0.5	5.0
GSTD1265PE-R68M	0.68	1.40	1.60	60.00	35.00	3.8 +/- 0.5	5.0
GSTD1265PE-R82M	0.82	1.60	1.90	50.00	33.00	3.8 +/- 0.5	5.0
GSTD1265PE-1R0M	1.00	1.70	2.00	49.00	32.00	3.8 +/- 0.5	5.0
GSTD1265PE-1R2M	1.20	2.10	2.50	48.00	30.00	3.8 +/- 0.5	5.0
GSTD1265PE-1R5M	1.50	2.50	3.00	45.00	27.00	3.8 +/- 0.5	5.0
GSTD1265PE-1R8M	1.80	2.80	3.20	41.00	24.00	3.8 +/- 0.5	5.0
GSTD1265PE-2R2M	2.20	3.50	4.20	40.00	22.00	3.8 +/- 0.5	5.0
GSTD1265PE-3R3M	3.30	5.70	6.80	35.00	18.00	3.8 +/- 0.5	5.0
GSTD1265PE-4R7M	4.70	9.30	11.20	30.00	13.50	3.8 +/- 0.5	5.0

* Test Condition : @100KHz , 1.0Vrms , 25deg.C Ambient

* Irms : Rated Current Loading when temperature rise approximately 40deg.C

* Isat : Saturated Current measured at the point of L drop approximately 30%

Product Series : GSTD	Brand : GOTREND
File Version : GSTD-SERIES-V6R1	Editor : Qiuyi Wu
Established Date : 2011.08.08	Description : High Current Inductor
Latest Edit Date : 2023.04.20	Product Type : <input checked="" type="checkbox"/> Standard <input type="checkbox"/> Customize

GSTD1265PE-SERIES

Dimension [mm] :

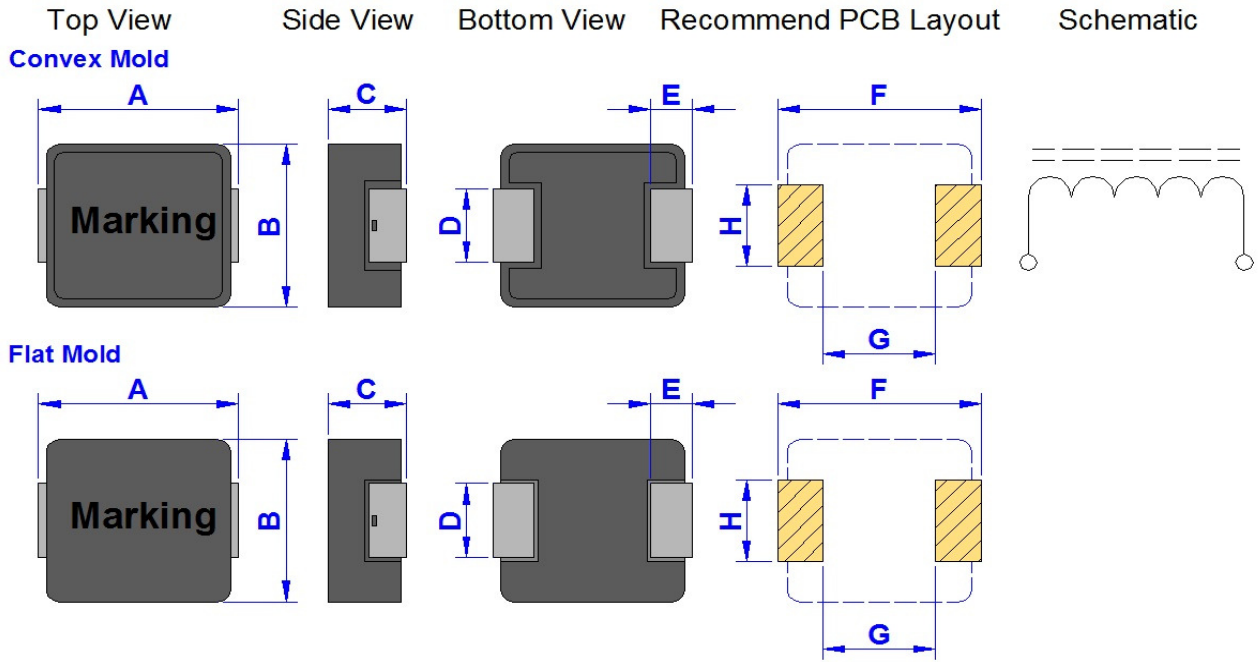

Size	A	B	C	D	E	F(Ref.)	G(Ref.)	H(Ref.)
1265PE	13.50+/-1.00	12.80+/-0.50	6.20+/-0.30	BY ITEM	2.50+/-0.50	15.00	6.00	BY ITEM

Electrical Characteristics :

Part No.	Inductance (uH) +/-20%	DCR (m Ohm) Typ.	DCR (m Ohm) Max.	Isat (Amp) Typ.	Irms (Amp) Typ.	Dimension "D" (mm)	Dimension "H" (mm) Ref.
GSTD1265PE-5R6M	5.60	11.80	12.80	26.50	12.00	3.8 +/- 0.5	5.0
GSTD1265PE-6R8M	6.80	13.10	14.00	16.50	11.50	3.8 +/- 0.5	5.0
GSTD1265PE-8R2M	8.20	14.50	15.50	16.00	10.50	3.8 +/- 0.5	5.0
GSTD1265PE-100M	10.00	15.80	16.80	15.50	10.00	3.8 +/- 0.5	5.0
GSTD1265PE-120M	12.00	23.00	26.00	14.00	9.00	3.8 +/- 0.5	5.0
GSTD1265PE-150M	15.00	25.00	29.00	9.00	6.00	3.8 +/- 0.5	5.0
GSTD1265PE-220M	22.00	34.00	39.00	7.50	5.00	3.8 +/- 0.5	5.0
GSTD1265PE-330M	33.00	55.00	65.00	6.00	4.00	3.8 +/- 0.5	5.0
GSTD1265PE-470M	47.00	80.00	92.00	5.00	3.00	3.8 +/- 0.5	5.0

* Test Condition : @100KHz , 1.0Vrms , 25deg.C Ambient

* I_{rms} : Rated Current Loading when temperature rise approximately 40deg.C

* I_{sat} : Saturated Current measured at the point of L drop approximately 30%

Product Series :	GSTD
File Version :	GSTD-SERIES-V6R1
Established Date :	2011.08.08
Latest Edit Date :	2023.04.20

Brand :	GOTREND
Editor :	Qiuyi Wu
Description :	High Current Inductor
Product Type :	<input checked="" type="checkbox"/> Standard <input type="checkbox"/> Customize

GSTD4020PE-SERIES

Current Characteristic :

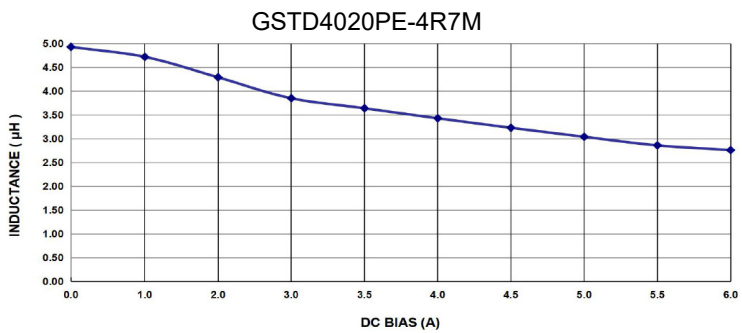
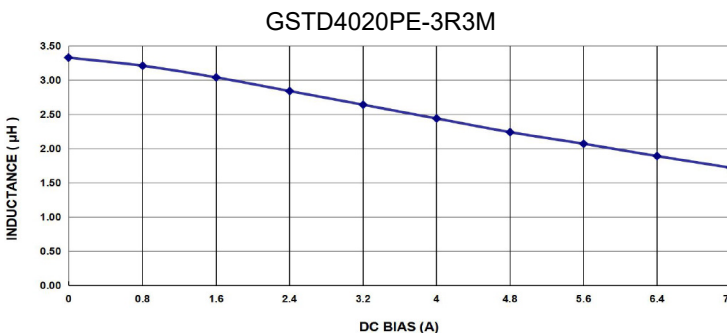
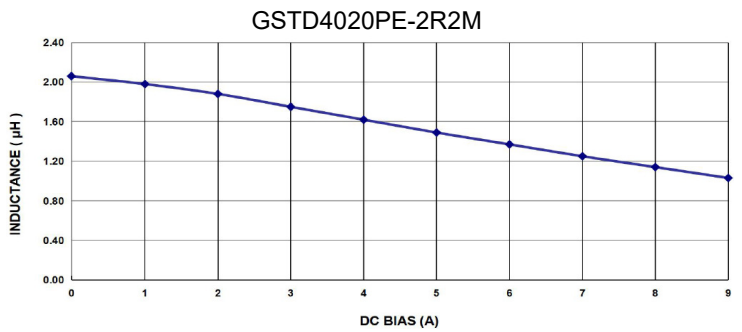
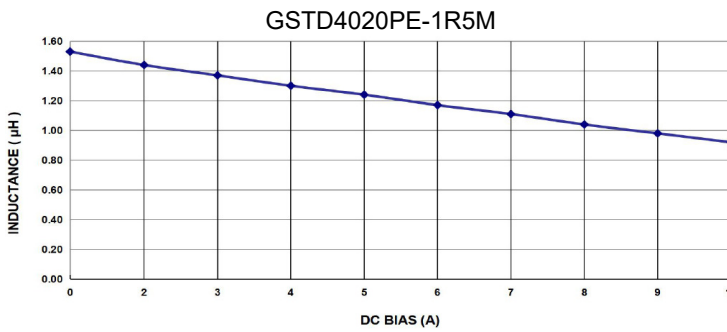
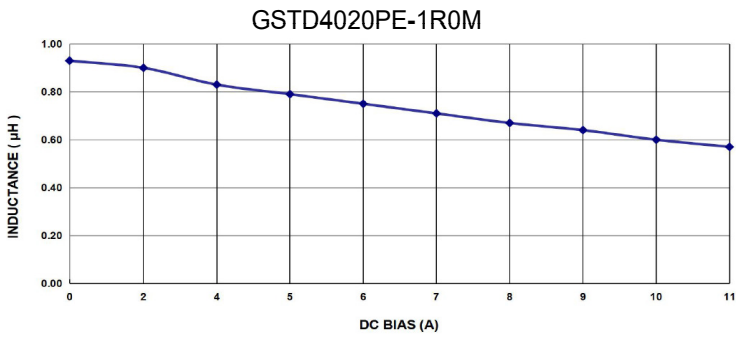
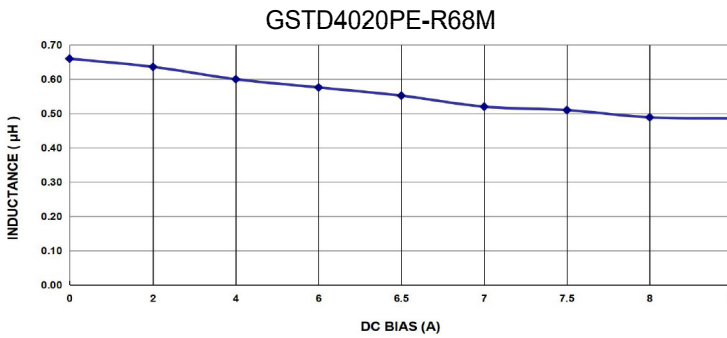
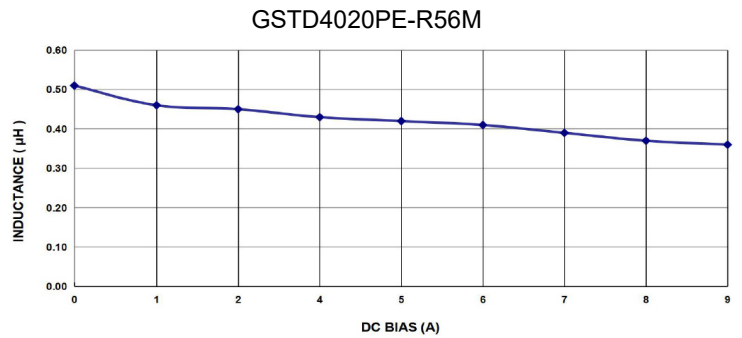
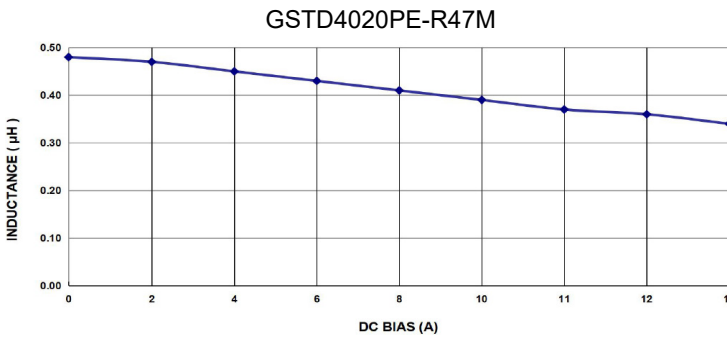
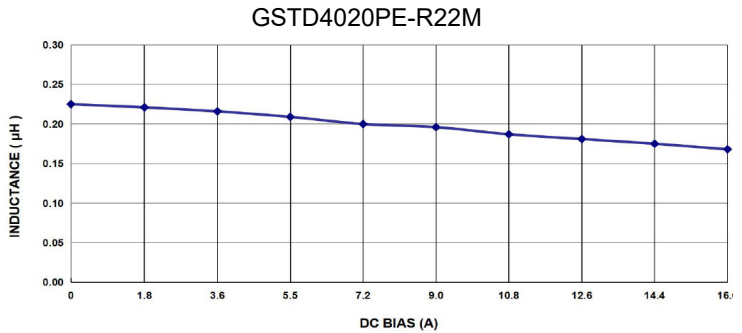
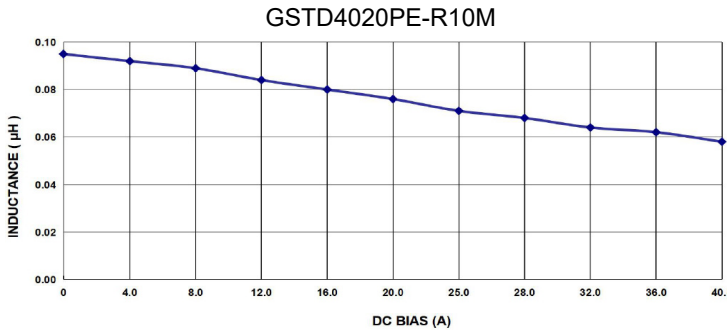

Product Series : GSTD	Brand : GOTREND
File Version : GSTD-SERIES-V6R1	Editor : Qiuyi Wu
Established Date : 2011.08.08	Description : High Current Inductor
Latest Edit Date : 2023.04.20	Product Type : <input checked="" type="checkbox"/> Standard <input type="checkbox"/> Customize

GSTD4020PE-SERIES

Current Characteristic :

GSTD4020PE-6R8M

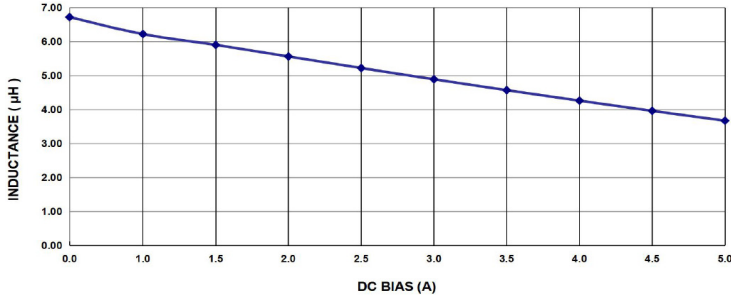

GSTD4020PE-100M

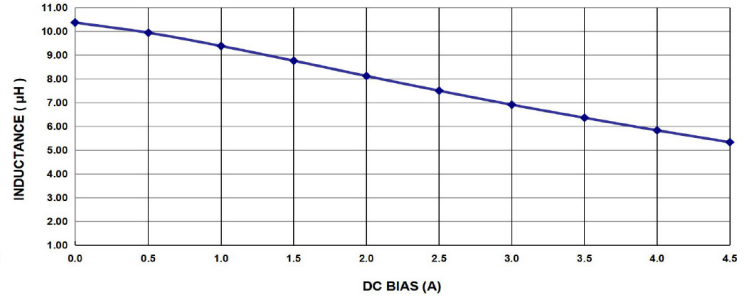

Product Series :	GSTD
File Version :	GSTD-SERIES-V6R1
Established Date :	2011.08.08
Latest Edit Date :	2023.04.20

Brand :	GOTREND
Editor :	Qiuyi Wu
Description :	High Current Inductor
Product Type :	<input checked="" type="checkbox"/> Standard <input type="checkbox"/> Customize

GSTD5030PE-SERIES

Current Characteristic :

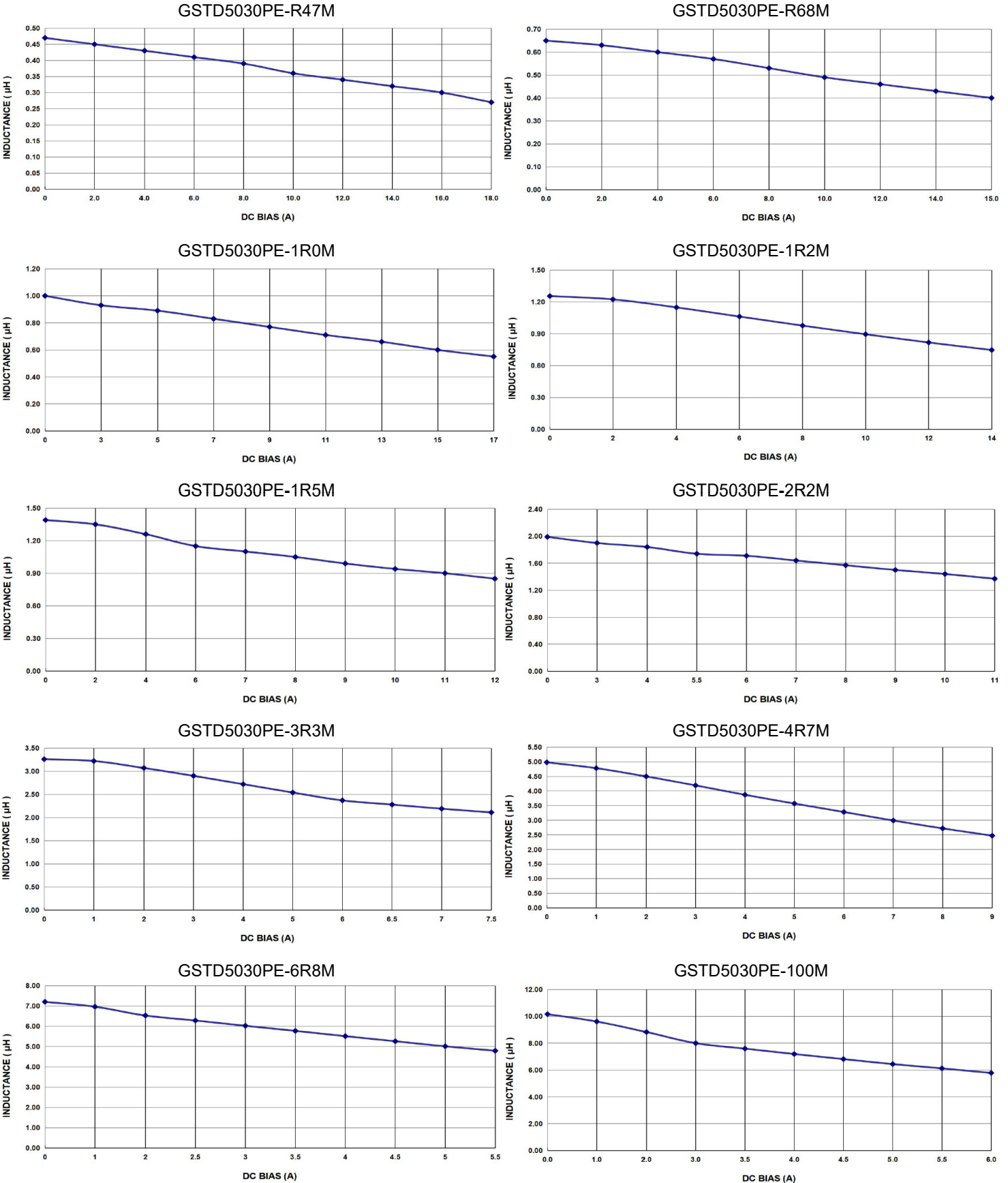

Product Series :	GSTD
File Version :	GSTD-SERIES-V6R1
Established Date :	2011.08.08
Latest Edit Date :	2023.04.20

Brand :	GOTREND
Editor :	Qiuyi Wu
Description :	High Current Inductor
Product Type :	<input checked="" type="checkbox"/> Standard <input type="checkbox"/> Customize

GSTD6030PE-SERIES

Current Characteristic :

GSTD6030PE-R10M

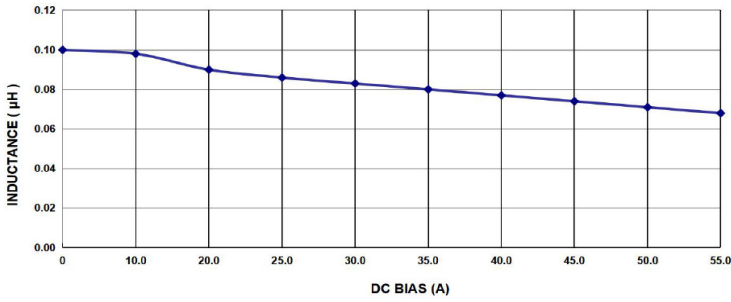

GSTD6030PE-R15M

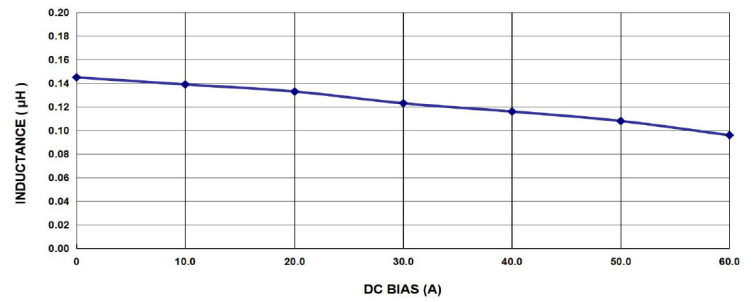

GSTD6030PE-R22M

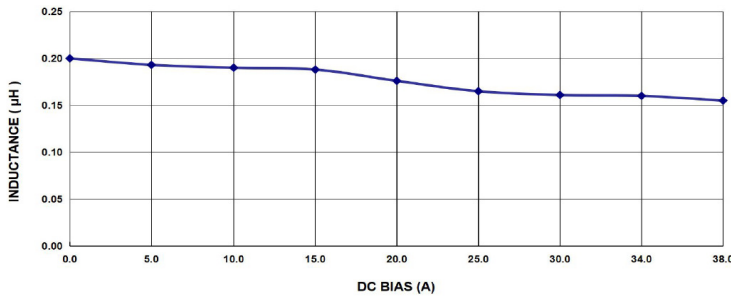

GSTD6030PE-R33M

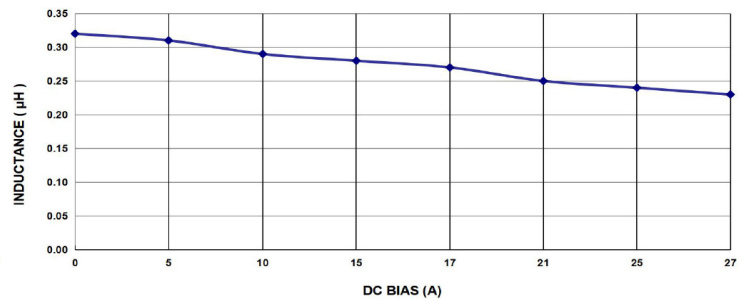

GSTD6030PE-R47M

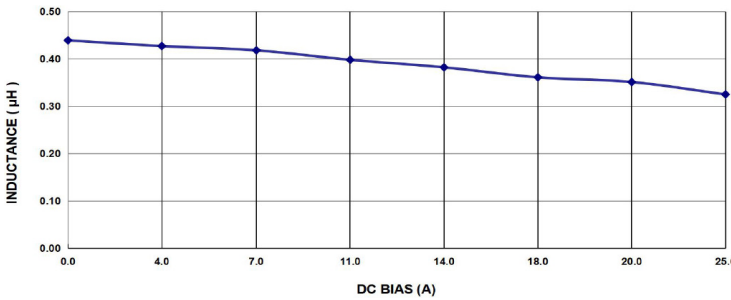

GSTD6030PE-R68M

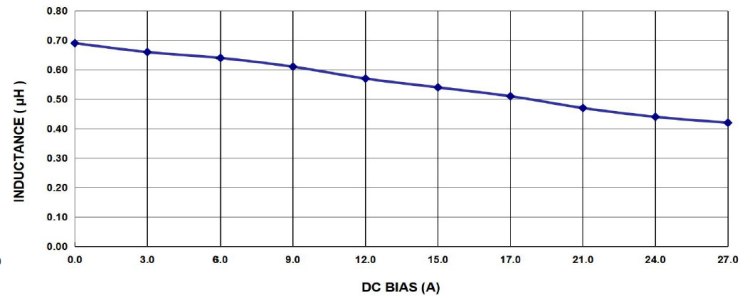

GSTD6030PE-R82M

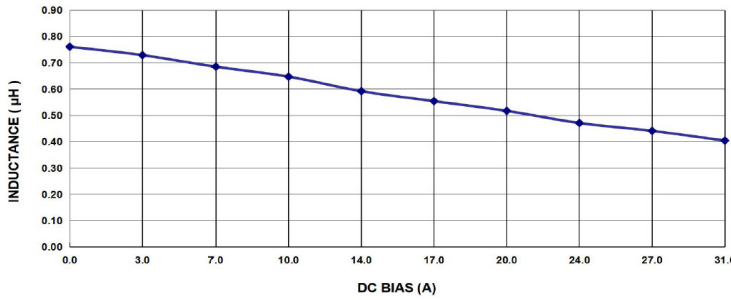

GSTD6030PE-1R0M

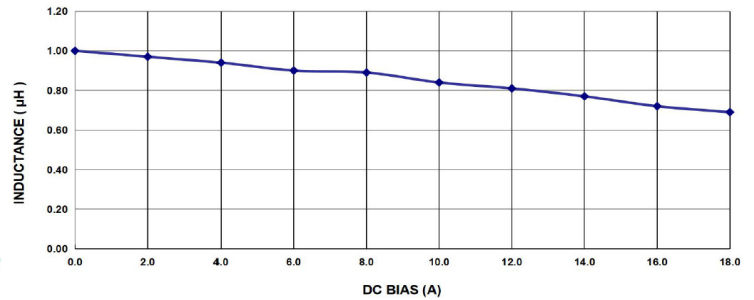

GSTD6030PE-1R5M

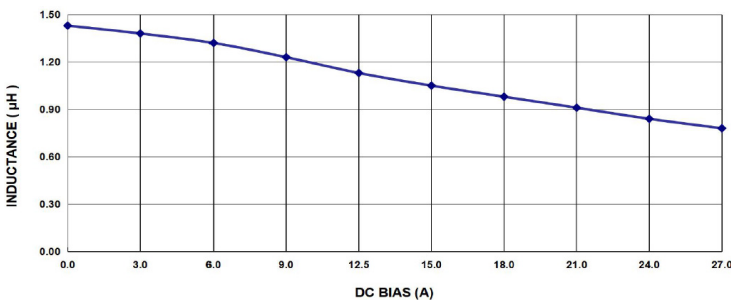

GSTD6030PE-2R2M

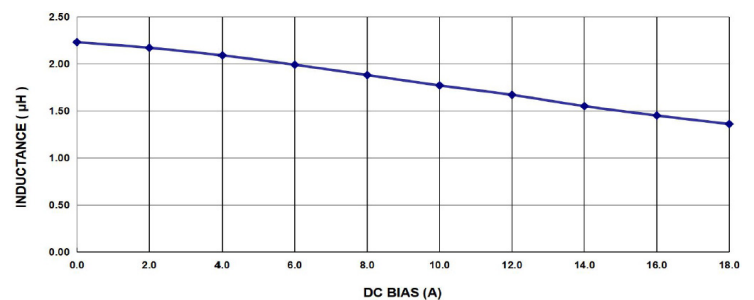

Product Series : GSTD
File Version : GSTD-SERIES-V6R1
Established Date : 2011.08.08
Latest Edit Date : 2023.04.20

Brand : GOTREND
Editor : Qiuyi Wu
Description : High Current Inductor
Product Type : <input checked="" type="checkbox"/> Standard <input type="checkbox"/> Customize

GSTD6030PE-SERIES

Current Characteristic :

GSTD6030PE-3R3M

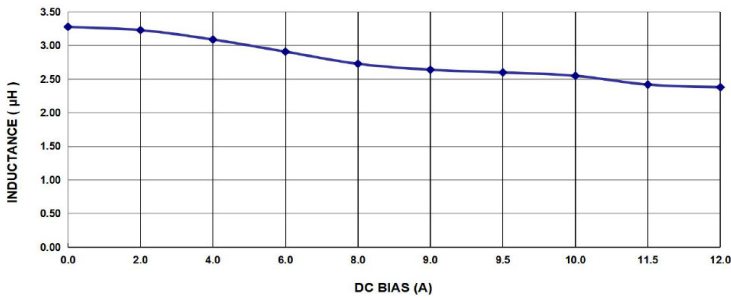

GSTD6030PE-4R7M

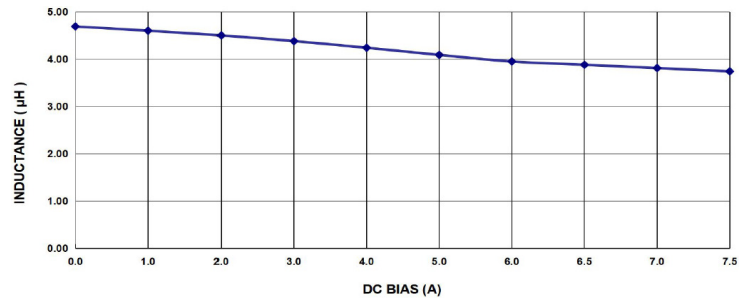

GSTD6030PE-6R8M

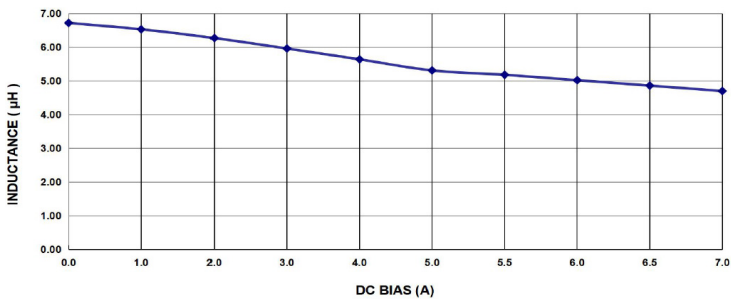

GSTD6030PE-8R2M

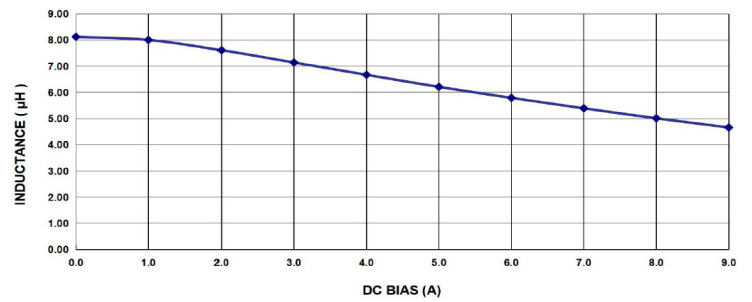

GSTD6030PE-100M

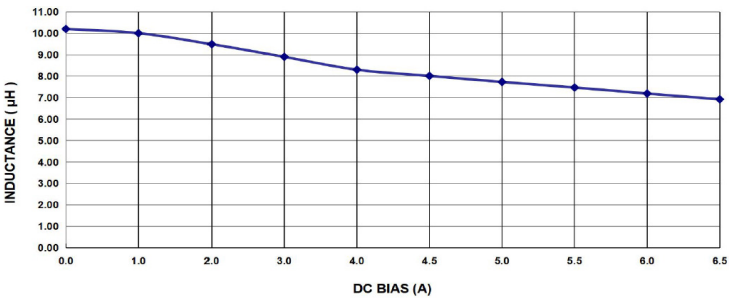

Product Series :	GSTD
File Version :	GSTD-SERIES-V6R1
Established Date :	2011.08.08
Latest Edit Date :	2023.04.20

Brand :	GOTREND
Editor :	Qiuyi Wu
Description :	High Current Inductor
Product Type :	<input checked="" type="checkbox"/> Standard <input type="checkbox"/> Customize

GSTD1040PE-SERIES

Current Characteristic :

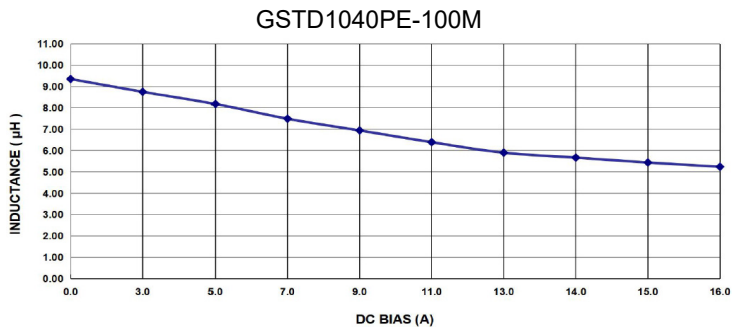
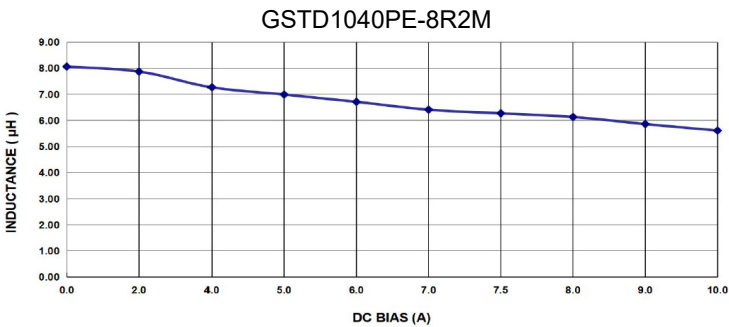
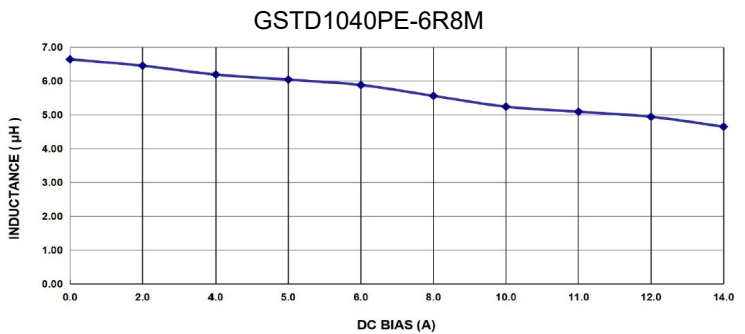
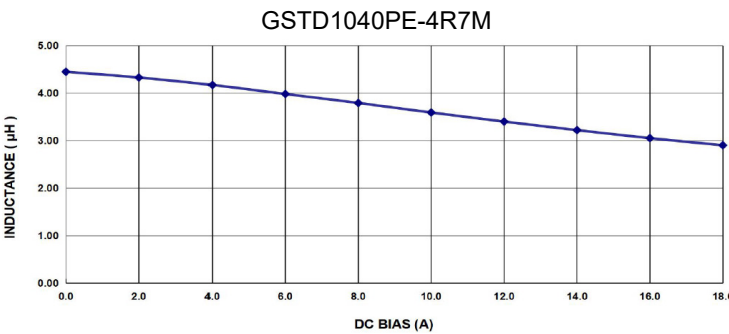
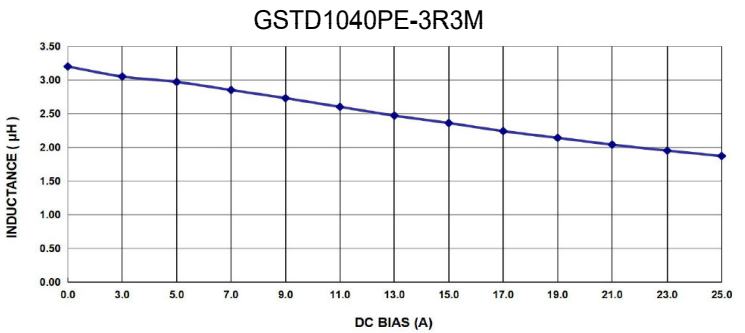
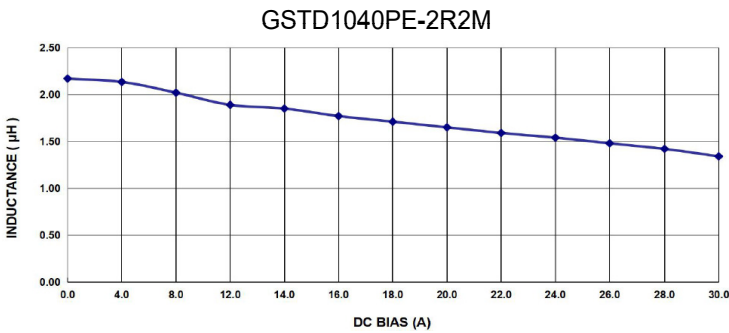
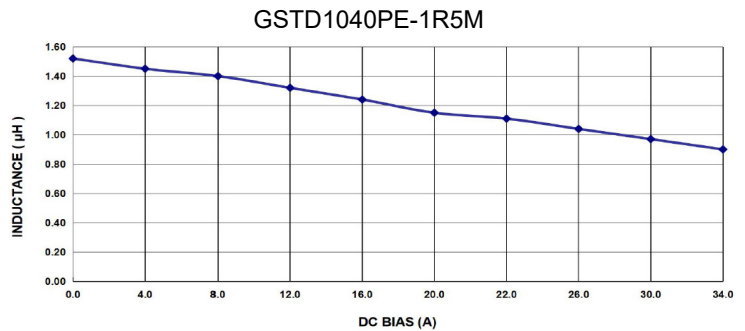
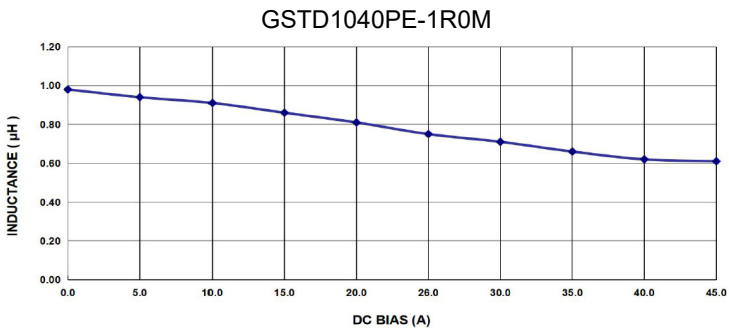
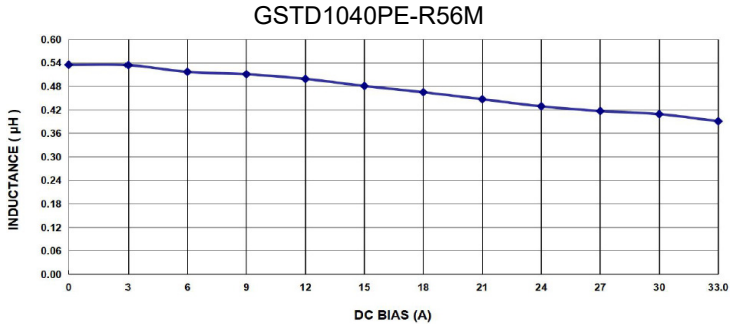
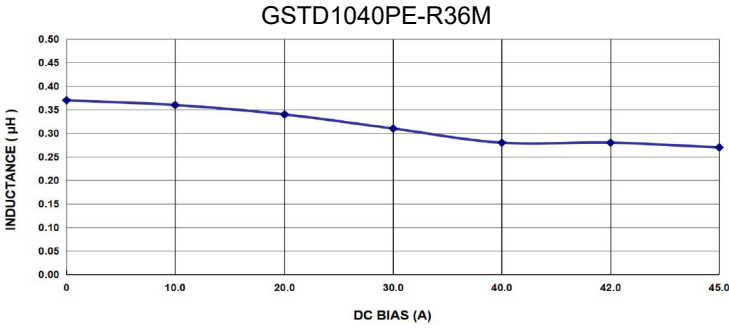

Product Series : GSTD	Brand : GOTREND
File Version : GSTD-SERIES-V6R1	Editor : Qiuyi Wu
Established Date : 2011.08.08	Description : High Current Inductor
Latest Edit Date : 2023.04.20	Product Type : <input checked="" type="checkbox"/> Standard <input type="checkbox"/> Customize

Care note :

Care note for Use :

(1) Storage Condition :

Temperature 25 to 35 deg.C , Humidity 45 to 60% RH

(2) Use Temperature :

- a. Minimum Temperature : -40 deg.C Ambient temperature of this product.
- b. Maximum Temperature : +125 deg.C The value of temperature including ambient and temperature rise of this product.
- c. Reliability test temperature range from -40 ~ +125 deg.C
- d. However, this is not meant as temperature grade guarantee for UL.

(3) Model :

When this product was used in a similar or as new product to the original one, sometimes it might be unable to satisfy the specifications due to difference in condition of usage.

(4) Drop :

If this product suffered mechanical stress such as drop, characteristics may become poor (due to damage on coil / bobbin / ferrite ... etc.)

Never use such stressed product.

Care note for Safety :

(1) Provision to Abnormal Condition :

This product itself does not have any protective function in abnormal condition such as overload, short-circuit and open-circuit conditions, etc.

Therefore, it shall be confirmed from the end product that there is no risk of smoking, fire, dielectric withstand voltage insulation resistance,etc. in abnormal conditions to provide protective devices and /or protection circuit in the end product.

(2) Temperature Rise :

Temperature rise on this product depends on the installation condition on end products.

It shall be confirmed on the actual end product that temperature rise of this product is within the specified temperature class limit.

(3) Dielectric Strength :

Dielectric withstanding test with higher voltage than specific value will damage insulating material and shorten its life.

(4) Water :

This product must not be used in wet condition resulted from water, coffee or any liquid contact because insulation strength becomes very low under such condition.

(5) Potting :

If this product is potted in some compound, coating material of magnet wire might be occasionally damaged. Please ask us if you intend to pot this product.

(6) Detergent :

Please consult our company immediately once under such circumstances because product reliability confirmation etc. is needed when this product come in contact with these chemicals.

Product Series : GSTD	Brand : GOTREND
File Version : GSTD-SERIES-V6R1	Editor : Qiuyi Wu
Established Date : 2011.08.08	Description : High Current Inductor
Latest Edit Date : 2023.04.20	Product Type : <input checked="" type="checkbox"/> Standard <input type="checkbox"/> Customize

Reliability :

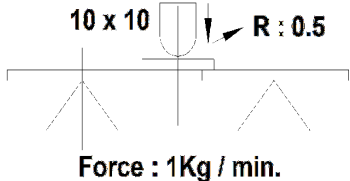
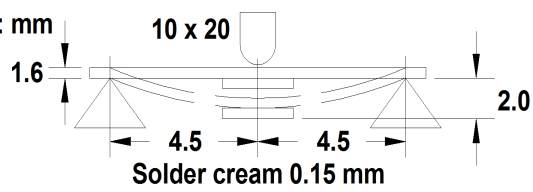
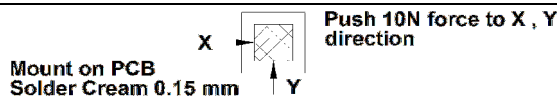
SN	Test Item	Test Condition	Specification												
1	Dimension	Actual Size ...	Meet Spec												
2	Thermal Shock (Temperature Cycle)	Temperature : -40 ~ +125 deg.C kept stabilized for 30 min. each Cycle : 100 Cycles (power off)	Elec. no variation Appearance no deformation												
3	Humidity Resistance	Humidity : 90% ~ 95% RH Temperature : 60 ± 2 deg.C, Test Time : 96 ± 2 Hours	Elec. no variation Appearance no deformation												
4	High Temperature	Temperature : 125 ± 2 deg.C Testing Time : 96 ± 2 Hours	Elec. no variation Appearance no deformation												
5	Low Temperature	Temperature : -40 ± 2 deg.C Time : 96 ± 2 Hours	Elec. no variation Appearance no deformation												
6	Temperature and Humidity Cycle	<table border="1"> <thead> <tr> <th>Temperature</th> <th>Humidity</th> <th>Time</th> </tr> </thead> <tbody> <tr> <td>25 deg.C</td> <td>90% ~ 95% RH</td> <td>3.0 Hr</td> </tr> <tr> <td>55 deg.C</td> <td>95% ~ 96% RH</td> <td>5.0 Hr</td> </tr> <tr> <td>25 deg.C</td> <td>90% ~ 95% RH</td> <td>3.0 Hr</td> </tr> </tbody> </table>	Temperature	Humidity	Time	25 deg.C	90% ~ 95% RH	3.0 Hr	55 deg.C	95% ~ 96% RH	5.0 Hr	25 deg.C	90% ~ 95% RH	3.0 Hr	Elec. no variation Appearance no deformation
		Temperature	Humidity	Time											
		25 deg.C	90% ~ 95% RH	3.0 Hr											
		55 deg.C	95% ~ 96% RH	5.0 Hr											
25 deg.C	90% ~ 95% RH	3.0 Hr													
Cycle : 20 Cycles															
7	Vibration	Frequency : 10Hz ~ 55Hz, Amplitude : 1.5 mm Direction : X, Y, Z, Time : 2 Hours each	Elec. no variation Appearance no deformation												
8	Solderability	Go through real SMT IR-Reflow The profile like our suggest profile. Preheat : 160 ± 10 deg.C (90 sec) Peak : 245 ± 5 deg.C Peak Time : 50 Sec. / up 217 deg.C	Elec. no variation Appearance no deformation												
9	Soldering Heat Resistance	Preheat : 160 ± 10 deg.C (90 sec) Solder : Sn / Ag / Cu (Pb Free) Solder Temp. : 260 ± 5 deg.C, Time : 3 ± 1 seconds	Elec. no variation Appearance no deformation												
10	Iron Solder Heat Resistance	Solder Temp. : 350 ± 5 deg.C Flux : Rosin, Time : 3 ± 1 seconds	Elec. no variation Appearance no deformation												
11	Bending Strength	<p>Unit : mm</p>  <p>Force : 1Kg / min.</p>	Elec. no variation Appearance no deformation												
12	Flexure Strength	<p>Unit : mm</p>  <p>Solder cream 0.15 mm</p>	Elec. no variation Appearance no deformation												
13	Terminal Strength	 <p>Mount on PCB Solder Cream 0.15 mm Push 10N force to X, Y direction</p>	Elec. no variation Appearance no deformation												
14	High-Voltage	100 V DC between core & winding	Elec. no variation Appearance no deformation												
15	Load life	Temperature : 25 ± 3 deg.C Load : Allowed DC Current, Test Time : 96 ± 2 Hours	Elec. no variation Appearance no deformation												

Product Series : GSTD	Brand : GOTREND
File Version : GSTD-SERIES-V6R1	Editor : Qiuyi Wu
Established Date : 2011.08.08	Description : High Current Inductor
Latest Edit Date : 2023.04.20	Product Type : <input checked="" type="checkbox"/> Standard <input type="checkbox"/> Customize

Packaging Information :

Tape Dimension (mm) :

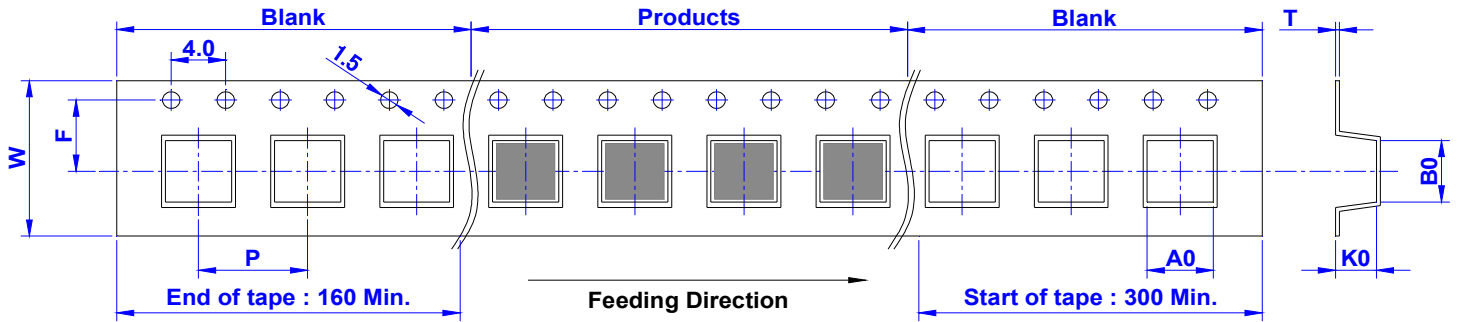

SIZE/mm	W	P	A0	B0	K0	T	F
4012	12.00	8.00	4.20	4.60	1.70	0.30	5.50
4012PM	12.00	8.00	4.55	4.75	1.50	0.30	5.50
4015	12.00	8.00	4.20	4.60	2.00	0.30	5.50
4020	12.00	8.00	4.20	4.60	2.50	0.30	5.50
5030	16.00	12.00	5.70	5.90	3.40	0.40	11.50
6018	16.00	12.00	6.90	7.60	2.00	0.40	7.50
6024	16.00	12.00	6.90	7.60	2.80	0.40	7.50
6030	16.00	12.00	6.90	7.60	3.40	0.40	7.50
6040	16.00	12.00	7.20	7.70	4.60	0.30	7.50
1040	24.00	16.00	11.00	12.60	4.10	0.40	11.50
1050	24.00	16.00	10.25	12.30	5.80	0.30	11.50
1250	24.00	16.00	13.10	14.90	5.30	0.40	11.50
1265	24.00	16.00	13.10	14.90	6.70	0.40	11.50

Product Series : GSTD	Brand : GOTREND
File Version : GSTD-SERIES-V6R1	Editor : Qiuyi Wu
Established Date : 2011.08.08	Description : High Current Inductor
Latest Edit Date : 2023.04.20	Product Type : <input checked="" type="checkbox"/> Standard <input type="checkbox"/> Customize

Packaging Information :

Reel Dimension (mm) :

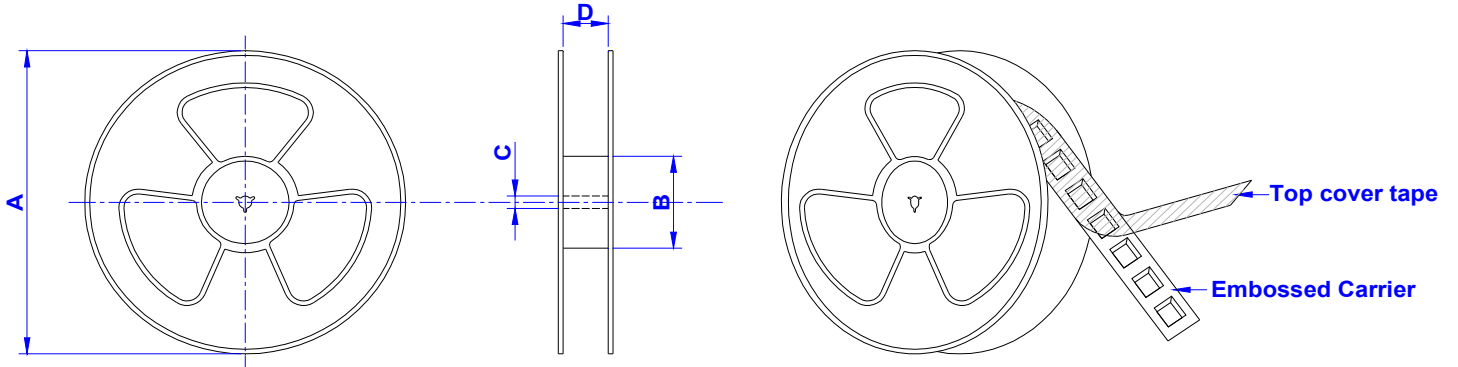

SIZE/mm	Reel Size	A	B	C	D	QTY / Reel
4012	13" x 12 mm	330	100	13	12.5	2000 PCS
4012PM	7" x 12 mm	178	60	13	12.5	3000 PCS
4015	13" x 12 mm	330	100	13	12.5	2000 PCS
4020	13" x 12 mm	330	100	13	12.5	2000 PCS
5030	13" x 16 mm	330	100	13	16.5	1500 PCS
6018PE	13" x 16 mm	330	100	13	16.5	2000 PCS
6018PW	13" x 16 mm	330	100	13	16.5	3000 PCS
6024	13" x 16 mm	330	100	13	16.5	1500 PCS
6030	13" x 16 mm	330	100	13	16.5	1000 PCS
6040	13" x 16 mm	330	100	13	16.5	1000 PCS
1040	13" x 24 mm	330	100	13	24.5	800 PCS
1050	13" x 24 mm	330	100	13	24.5	700 PCS
1250	13" x 24 mm	330	100	13	24.5	500 PCS
1265	13" x 24 mm	330	100	13	24.5	400 PCS

Tearing Off Force :

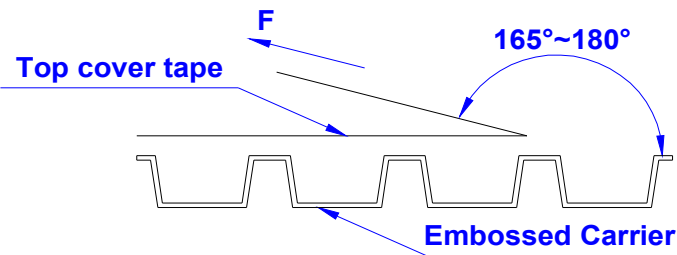

The force for tearing off cover tape is 10 to 130 grams in the arrow direction under the following conditions (referenced ANSI / EIA - 481 - D - 2008 of 4.11stadnard).

Room Temp. (deg.C)	Room Humidity (%)	Room Atm. (hPa)	Tearing Speed (mm / min)
5 ~ 35	45 ~ 85	860 ~ 1060	300

Product Series : GSTD	Brand : GOTREND
File Version : GSTD-SERIES-V6R1	Editor : Qiuyi Wu
Established Date : 2011.08.08	Description : High Current Inductor
Latest Edit Date : 2023.04.20	Product Type : <input checked="" type="checkbox"/> Standard <input type="checkbox"/> Customize

Packaging Information :

Box Package :

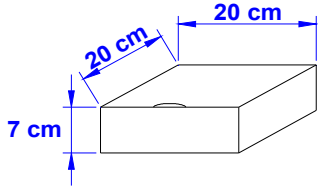

7" Small Box

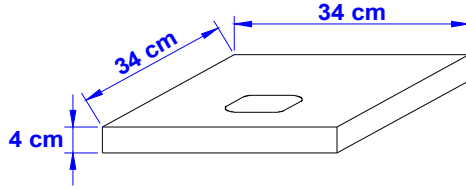

13" Small Box

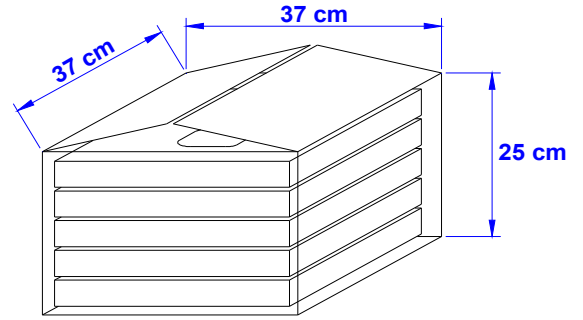

Large Box

SIZE/mm	Reels in Small Box(QTY)	Small Box in Large Box(QTY)
4012	2(4000)	5(20000)
4012PM	4(12000)	8(96000)
4015	2(4000)	5(20000)
4020	2(4000)	5(20000)
5030	1(1500)	5(7500)
6018PE	1(2000)	5(10000)
6018PW	1(3000)	5(15000)
6024	1(1500)	5(7500)
6030	1(1000)	5(5000)
6040	1(1000)	5(5000)
1040	1(800)	5(4000)
1050	1(700)	5(3500)
1250	1(500)	5(2500)
1265	1(400)	5(2000)