



Product Series :	GSTU	Brand :	GOTREND
File Version :	GSTU-SERIES	Editor :	Yinghui Guo
Established Date	2025.03.27	Description :	High Current Inductor
Latest Edit Date :	2025.04.01	Product Type :	<input checked="" type="checkbox"/> Standard <input type="checkbox"/> Customize

REMINDERS

- ◆ Product information in this catalog is subject to change without notice, and is for reference only. Therefore, please contact GOTREND Technology to check for the latest information before practical application or usage of the products.
- ◆ This catalog contains only typical specifications, please contact GOTREND Technology for further details if you can not find special components or information you need in this catalogue. Please also approve our product specifications or transact the approval sheet for product specifications before ordering.
- ◆ This catalogue only applies to products purchased through GOTREND Technology or its official agencies. This catalogue does not apply to products that are purchased through other third parties.
- ◆ Please read Attention and CAUTION note (for storage, operating, rating, soldering, mounting and handling) in this catalog to ensure product proper usage.
- ◆ GOTREND Technology is not responsible for issues that occur related to the intellectual property rights or other rights of our company or a third party when you use a product listed in this catalog. GOTREND Technology do not grant license of these rights.
- ◆ Information and data provided in the brochure can and do vary in different applications, and actual performance may vary over time.
- ◆ "Delivery Specification" illustrating precautions for the specifications and safety of each product listed in this catalog is available and we strongly recommend to provide these delivery specifications with customers that use these products.
- ◆ For exporting of product in this catalog, please take note it may be a restricted item according to the "Foreign Exchange and Foreign Trade Control Law". In such cases, it is necessary to acquire export permission in accordance to this law.
- ◆ Any reproduction or extraction of the contents in this catalog is prohibited without prior permission from GOTREND Technology.
- ◆ Products listed in this catalog are intended for general electronic device usage under normal operation and use condition including telecommunication equipment, home appliances, sports equipment AV equipment, industrial machine, office equipment etc. Please take note that our products are not designed, intended or authorized for use in below mentioned applications unless explicitly agreed in writing between the parties to avoid product failure that could result in situation where personal injury or death could occur.

- (1) Aerospace/Aviation equipment
- (2) Atomic energy-related equipment
- (3) Disaster prevention/crime prevention equipment
- (4) Electric heating apparatus, burning equipment
- (5) Medical equipment
- (6) Military equipment
- (7) Power-generation control equipment
- (8) Public information-processing equipment
- (9) Safety equipment
- (10) Seabed equipment
- (11) Transportation control equipment
- (12) Transportation equipment (cars, electric trains, ships, etc.)
- (13) Other applications that are not considered general-purpose applications

- ◆ Our manufacturing sites fully compliance with requirement regarding the quality management system in the automotive industry under the IATF 16949 standard. GOTREND Technology respect individual agreements with reference to customer requirements and customer specific requirements (CSR). We will like to emphasize that only requirements mutually agreed upon will in implemented in our Quality Management System taking into consideration that IATF 16949 may appear to support the acceptance of unilateral requirements. We will only legally bind to this individually agreed upon agreement under the IATF 16949 standard.
- ◆ The product itself is a powder metallurgy product, so the structure is relatively fragile, and it should not be used for products that are easy to fall. In addition, when this product is assembled, it should avoid collision with the tool or mechanism shell. 
- ◆ It is not recommended to use hot air gun for disassembling of this product. When using of hot air gun to repair other parts, please also take note that long time or high temperature exposure of this product will also damage the inductance device. If you need to use the hot air gun to disassemble the product, it is recommended to adjust the hot air gun temperature to 380 deg.C±5 deg.C. The blower head of the hot air gun should be perpendicular and at least 1cm away from the product. After heating the product to the tin material melting point, use tweezers to remove the product from the PCB. 

Product Series :	GSTU	Brand :	GOTREND
File Version :	GSTU-SERIES	Editor :	Yinghui Guo
Established Date	2025.03.27	Description :	High Current Inductor
Latest Edit Date :	2025.04.01	Product Type :	<input checked="" type="checkbox"/> Standard <input type="checkbox"/> Customize

Features & Application :

- * Compact design.
- * High current , low DCR , high efficiency.
- * Very low acoustic noise and very low leakage flux noise.
- * High reliability.
- * 100% Lead (Pb) - Free and RoHS compliant.
- * Note PC power system , incl. IMVP-6 , DC / DC converter.

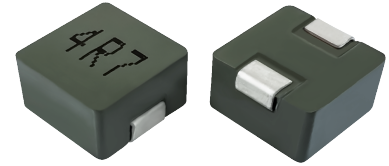

(Picture for reference only)

Part No. Example :

PN	:	GSTU	4020	P	A	-	1R0	M
-----		-----	-----	---	---		-----	---
ID	:	1	2	3	4		5	6
1	:	GOTREND Series : GSTU						
2	:	Type Size Code : 4020 = 4.6 x 4.1 x 2.0 mm						
3	:	P = Pb free < 1000 ppm						
4	:	[A] : Alloy Powder ; [C] : Carbonyl Iron Powder						
5	:	Inductance : 1R0 = 1.0 uH						
6	:	Tolerance : M = +/-20%						

Basic Information :

Made in	China
Pin Foot	SMD
Shielding	Yes
J-STD-020	MSL Level 1
RoHS	Compliant
REACH	Compliant
Halogen	Free

Operating & Storage Condition :

- * Operating Temp -40 ~ +125 °C (Including self - temperature rise)
- * Storage Temp 1. -10 ~ +45 °C , 50 ~ 60% RH (Product with taping)
 2. -40 ~ +125 °C (On board)
- * Storage Life Time 6 Month (Less than 40 °C and 60% RH)

Attention & Caution :

- * Keep out of Splashing water or salt water
- * Avoid Toxic Gas (Hydrogen sulfide, Sulfurous acid, Chlorine, Ammonia)
-  Vibrations or shocks which exceed the specified condition
- Dew condense
- Layout near the edge of PCB
- Over flexure after SMT mounting & PCBA

- * Pin foot or SMD pad solderability: Pb free type is best within 6 months after delivery
- * Humidity sensitive , IPC/JEDEC J-STD-020 MSL if over Level 1, recommend bake 30mins@150 degree before PCBA
- * Caution for human life relative applications : PLS contact & consult with GOTREND team in design stage.

Test Condition :

- * Equipment HP4284A , HP42841A - L , Q , DCR , IDC
 HP8753D Network analyzer - SRF
- * Standard Atmosphere Conditions:
 Ambient Temperature 20 ± 15 °C
 Humidity RH 65 ± 20%
- * If there may be any doubt on the test result ,
 Measurement shall be made within the following limits:
 Ambient Temperature 25 ± 5 °C
 Humidity RH 75 ± 10%

Recommend IR Reflow Curve : GTX-IR-FILE001

Lead Free Solder : A = 217 deg.C , B = 245+/-5 deg.C
Time : C = 40 ~ 60 Sec.

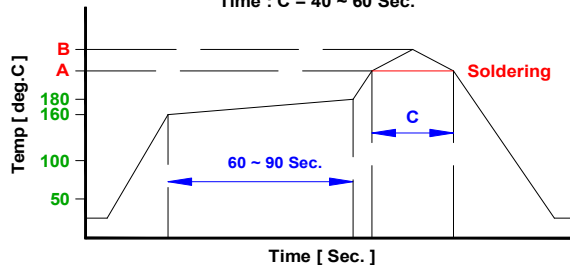

Notice : Iron Soldering , Solder < 30 Watt ,
Direct touch the terminal x 3 Sec. Max. @ 350 deg.C

Product Series : GSTU	Brand : GOTREND
File Version : GSTU-SERIES	Editor : Yinghui Guo
Established Date 2025.03.27	Description : High Current Inductor
Latest Edit Date : 2025.04.01	Product Type : <input checked="" type="checkbox"/> Standard <input type="checkbox"/> Customize

High Current Inductor - GSTU Series Type

Part Name	L (mm) Typ.	W (mm) Typ.	H (mm) Typ.	Inductance Range (uH) M=+/-20%	DCR (m Ohm) Max.	Isat (A) Typ.	Irms (A) Typ.	Page
GSTU4020PA	4.6	4.1	2.0	0.47 ~ 10.00	14.0 ~ 258.0	2.0 ~ 9.5	1.6 ~ 7.0	5 ~ 6
GSTU5018PA	5.7	5.2	1.8	0.47 ~ 10.00	9.0 ~ 155.0	3.0 ~ 13.0	2.5 ~ 9.0	7 ~ 8
GSTU5020PA	5.7	5.2	2.0	0.22 ~ 10.00	6.50 ~ 180.0	3.0 ~ 17.0	2.3 ~ 12.0	9 ~ 10
GSTU5030PA	5.7	5.2	3.0	0.22 ~ 22.00	5.0 ~ 270.0	2.0 ~ 21.0	2.0 ~ 15.5	11 ~ 12
GSTU6018PA	7.1	6.6	1.8	0.22 ~ 10.00	5.2 ~ 165.0	2.5 ~ 29.0	2.3 ~ 14.0	13 ~ 14
GSTU6020PA	7.1	6.6	2.0	0.47 ~ 6.80	8.4 ~ 105.0	4.2 ~ 18.0	3.0 ~ 11.0	15 ~ 16
GSTU6024PA	7.1	6.6	24	0.22 ~ 15.00	3.5 ~ 160.0	3.3 ~ 30.0	2.5 ~ 16.0	17 ~ 18
GSTU6030PA	7.1	6.6	3.0	0.22 ~ 33.00	2.8 ~ 270.0	3.0 ~ 40.0	2.0 ~ 23.0	19 ~ 20
GSTU6040PA	7.1	6.6	4.0	0.33 ~ 47.00	3.5 ~ 280.0	2.5 ~ 30.0	2.1 ~ 20.0	21 ~ 22
GSTU6050PA	7.1	6.6	5.0	0.36 ~ 47.0	4.0 ~ 290.0	2.8 ~ 23.0	2.0 ~ 15.0	23 ~ 24
GSTU8040PA	8.7	8.1	4.0	0.82 ~ 47.00	4.0 ~ 180.0	2.8 ~ 22.0	2.5 ~ 18.0	25 ~ 26
GSTU8050PA	8.7	8.1	5.0	1.00 ~ 68.00	5.5 ~ 300.0	3.0 ~ 18.0	2.0 ~ 16.0	27 ~ 28
GSTU1040PA	11.0	10.1	4.0	0.22 ~ 100.00	0.8 ~ 300.0	2.0 ~ 45.0	1.5 ~ 30.0	29 ~ 31
GSTU1050PA	11.0	10.1	5.0	0.33 ~ 100.00	0.9 ~ 250.0	2.5 ~ 38.0	1.5 ~ 28.0	32 ~ 33
GSTU1250PA	13.8	12.6	5.0	0.47 ~ 100.0	1.3 ~ 270.0	3.0 ~ 52.0	2.0 ~ 30.0	34 ~ 35
GSTU1260PA	13.8	12.6	6.0	4.70 ~ 100.0	11.0 ~ 210.0	4.0 ~ 20.0	2.3 ~ 12.0	36 ~ 37
GSTU1265PA	13.8	12.6	6.5	0.47 ~ 100.0	1.2 ~ 220.0	4.5 ~ 60.0	2.5 ~ 30.0	38 ~ 39

Product Series : GSTU	Brand : GOTREND
File Version : GSTU-SERIES	Editor : Yinghui Guo
Established Date : 2025.03.27	Description : High Current Inductor
Latest Edit Date : 2025.04.01	Product Type : <input checked="" type="checkbox"/> Standard <input type="checkbox"/> Customize

GSTU4020PA-SERIES

Dimension [mm] :

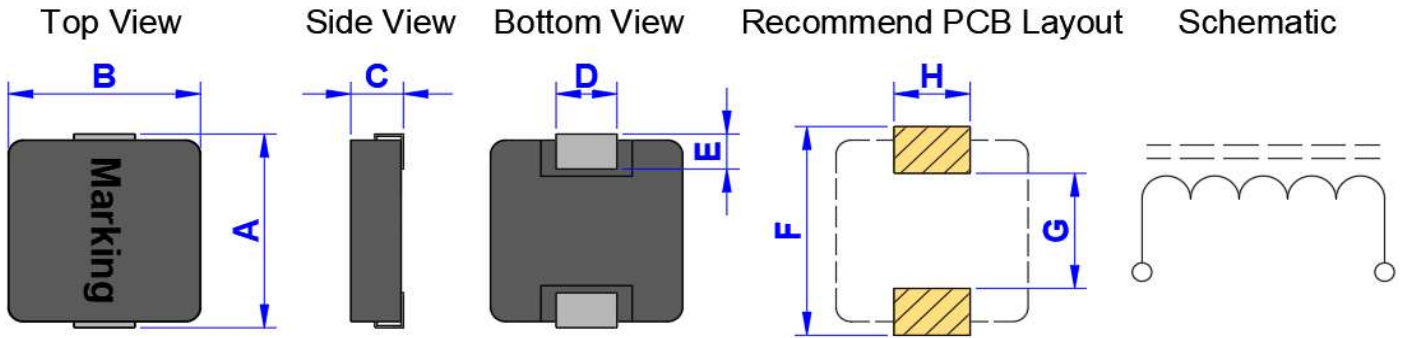

Marking : Inductance code

A(+/-0.2)	B(+/-0.25)	C(Max.)	D(+/-0.3)	E(+/-0.5)	F(Ref.)	G(Ref.)	H(Ref.)
4.6	4.1	2.0	1.5	1.0	5.2	2.2	2.5

Electrical Characteristics :

Part No.	Inductance (uH)	Inductance Tolerance	DCR (mΩ) (Max.)	Isat (Amp) (Typ.)	Irms (Amp) (Typ.)
GSTU4020PA-R47M	0.47	M	14.0	9.5	7.0
GSTU4020PA-R68M	0.68	M	21.0	8.0	5.2
GSTU4020PA-1R0M	1.00	M	27.0	7.0	4.5
GSTU4020PA-1R5M	1.50	M	46.0	6.0	4.0
GSTU4020PA-2R2M	2.20	M	58.0	5.0	3.0
GSTU4020PA-3R3M	3.30	M	87.0	4.0	2.5
GSTU4020PA-4R7M	4.70	M	126.0	3.0	2.2
GSTU4020PA-5R6M	5.60	M	132.0	2.8	2.1
GSTU4020PA-6R8M	6.80	M	145.0	2.5	2.0
GSTU4020PA-8R2M	8.20	M	216.0	2.5	2.0
GSTU4020PA-100M	10.00	M	258.0	2.0	1.6

* Test Condition : @100KHz , 1.0Vrms , 25°C Ambient

* Inductance Tolerance : M = +/-20%

* I_{rms} : Rated Current Loading when temperature rise approximately 40°C.

* Isat : Saturated Current measured at the point of L drop approximately 30%.

* Absolute maximum voltage : 30VDC.

Typical Performance Curves :

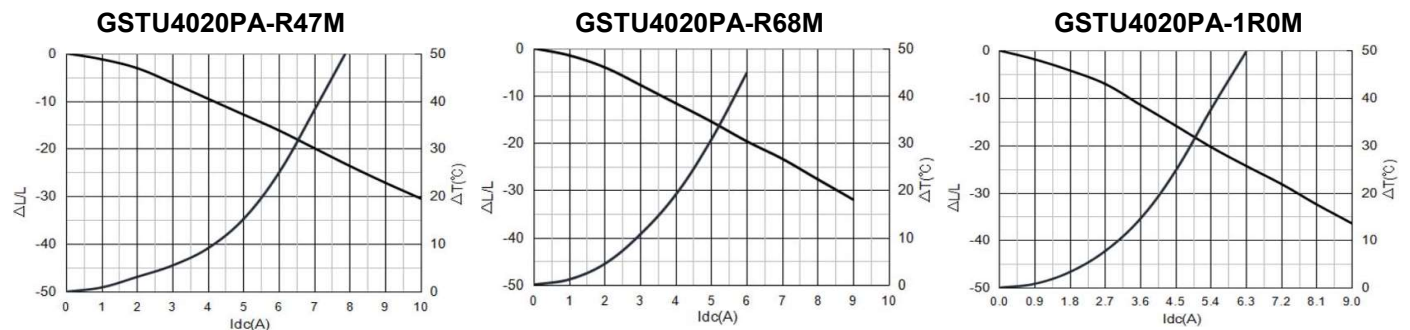

Product Series : GSTU	Brand : GOTREND
File Version : GSTU-SERIES	Editor : Yinghui Guo
Established Date 2025.03.27	Description : High Current Inductor
Latest Edit Date : 2025.04.01	Product Type : <input checked="" type="checkbox"/> Standard <input type="checkbox"/> Customize

GSTU4020PA-SERIES

Typical Performance Curves :

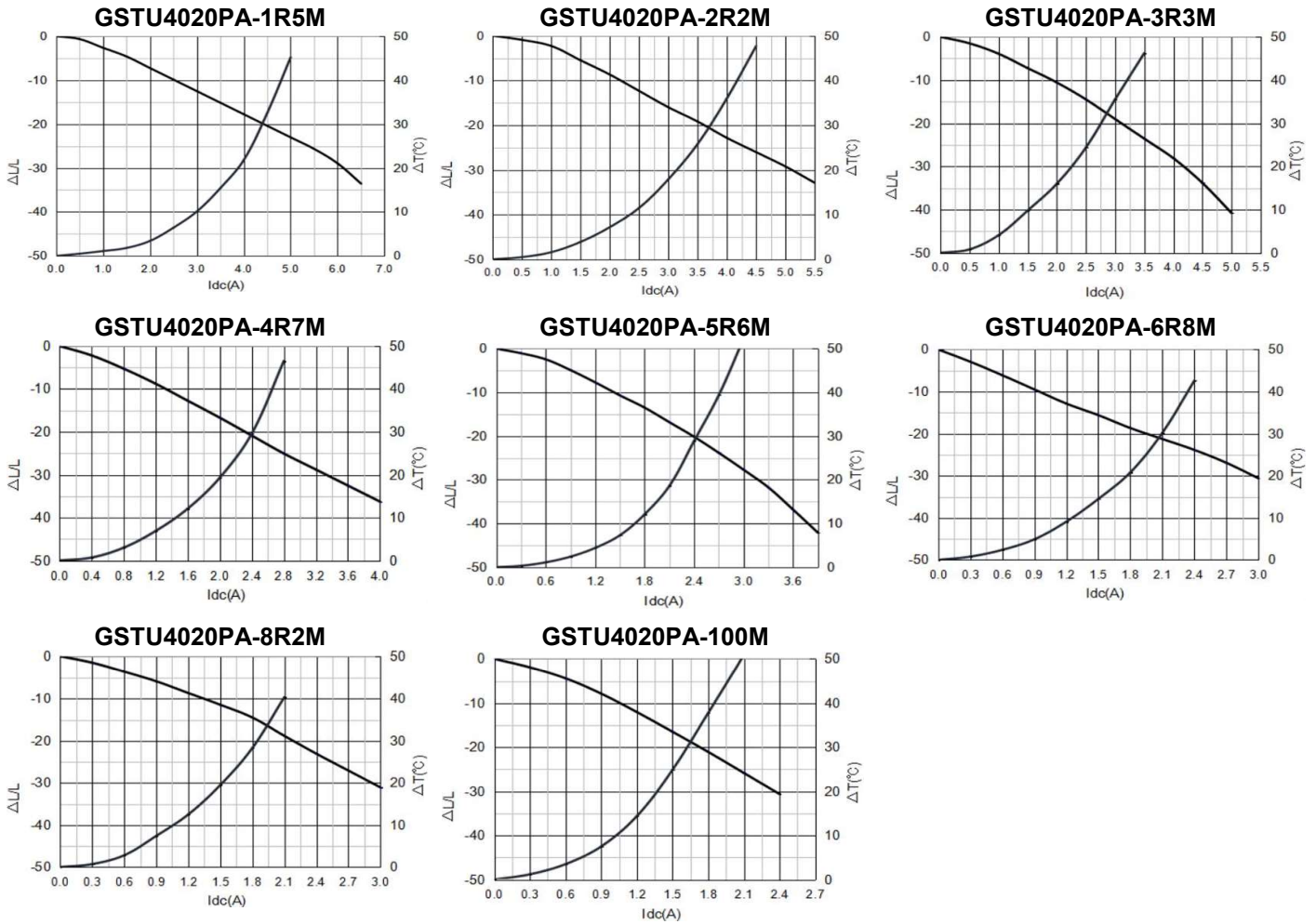

Product Series : GSTU	Brand : GOTREND
File Version : GSTU-SERIES	Editor : Yinghui Guo
Established Date 2025.03.27	Description : High Current Inductor
Latest Edit Date : 2025.04.01	Product Type : <input checked="" type="checkbox"/> Standard <input type="checkbox"/> Customize

GSTU5018PA-SERIES

Dimension [mm] :

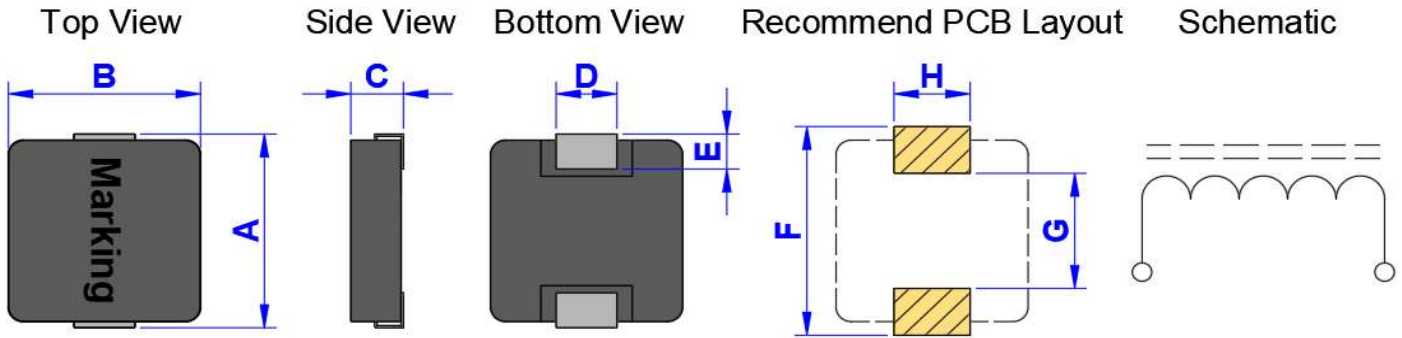

Marking : Inductance code

A(+/-0.2)	B(+/-0.2)	C(Max.)	D(+/-0.3)	E(+/-0.3)	F(Ref.)	G(Ref.)	H(Ref.)
5.7	5.2	1.8	2.0	1.5	6.0	2.2	2.5

Electrical Characteristics :

Part No.	Inductance (uH)	Inductance Tolerance	DCR (mΩ) (Max.)	Isat (Amp) (Typ.)	Irms (Amp) (Typ.)
GSTU5018PA-R47M	0.47	M	9.0	13.0	9.0
GSTU5018PA-R68M	0.68	M	14.0	12.0	8.5
GSTU5018PA-1R0M	1.00	M	17.0	9.0	8.0
GSTU5018PA-1R5M	1.50	M	25.0	7.0	6.0
GSTU5018PA-2R2M	2.20	M	38.0	6.5	5.0
GSTU5018PA-3R3M	3.30	M	58.0	5.0	4.5
GSTU5018PA-4R7M	4.70	M	85.0	4.0	3.5
GSTU5018PA-6R8M	6.80	M	125.0	3.4	2.8
GSTU5018PA-100M	10.00	M	155.0	3.0	2.5

- * **Test Condition :** @100KHz , 1.0Vrms , 25°C Ambient
- * **Inductance Tolerance :** M = +/-20%
- * **Irms :** Rated Current Loading when temperature rise approximately 40°C.
- * **Isat :** Saturated Current measured at the point of L drop approximately 30%.
- * **Absolute maximum voltage :** 30VDC.

Typical Performance Curves :

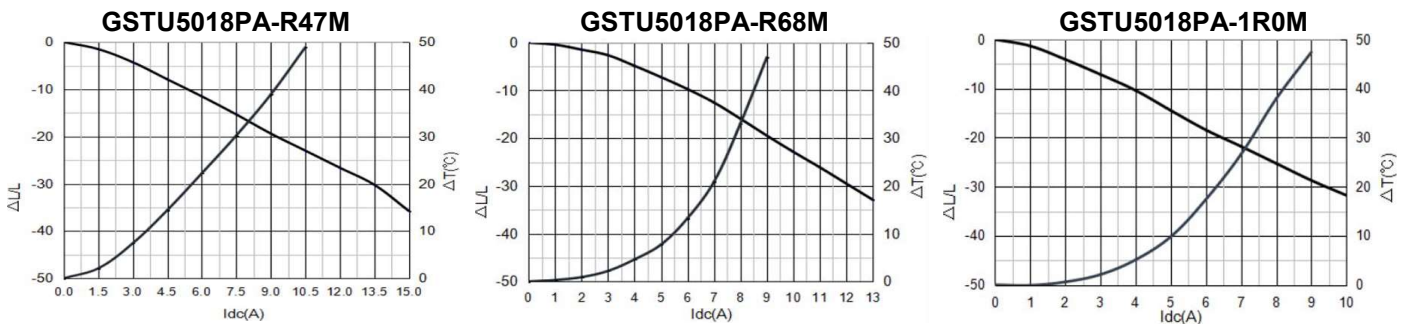

Product Series : GSTU
File Version : GSTU-SERIES
Established Date 2025.03.27
Latest Edit Date : 2025.04.01

Brand : GOTREND
Editor : Yinghui Guo
Description : High Current Inductor
Product Type : Standard Customize

GSTU5018PA-SERIES

Typical Performance Curves :

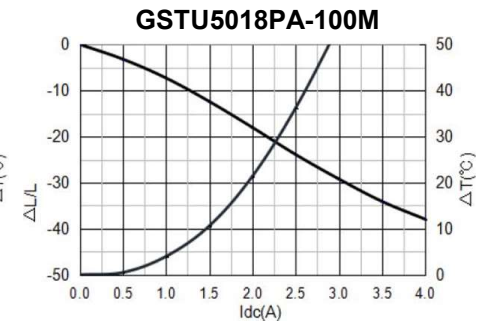
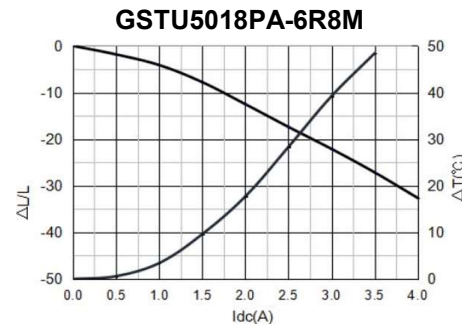
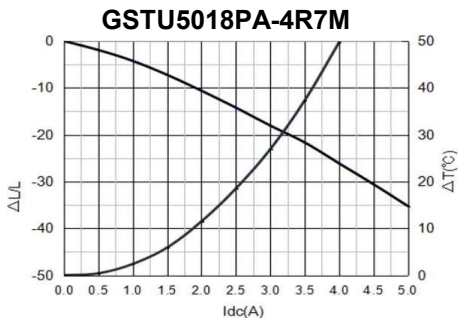
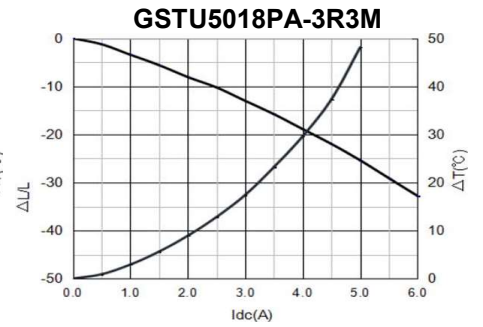
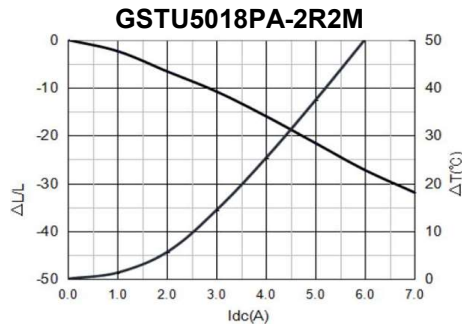
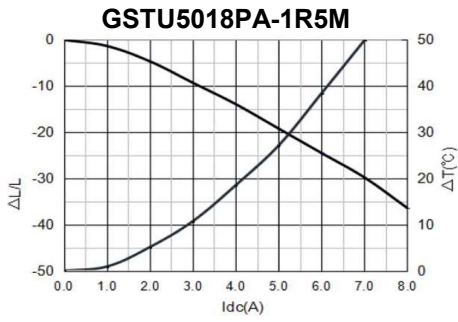

Product Series : GSTU	Brand : GOTREND
File Version : GSTU-SERIES	Editor : Yinghui Guo
Established Date 2025.03.27	Description : High Current Inductor
Latest Edit Date : 2025.04.01	Product Type : <input checked="" type="checkbox"/> Standard <input type="checkbox"/> Customize

GSTU5020PA-SERIES

Dimension [mm] :

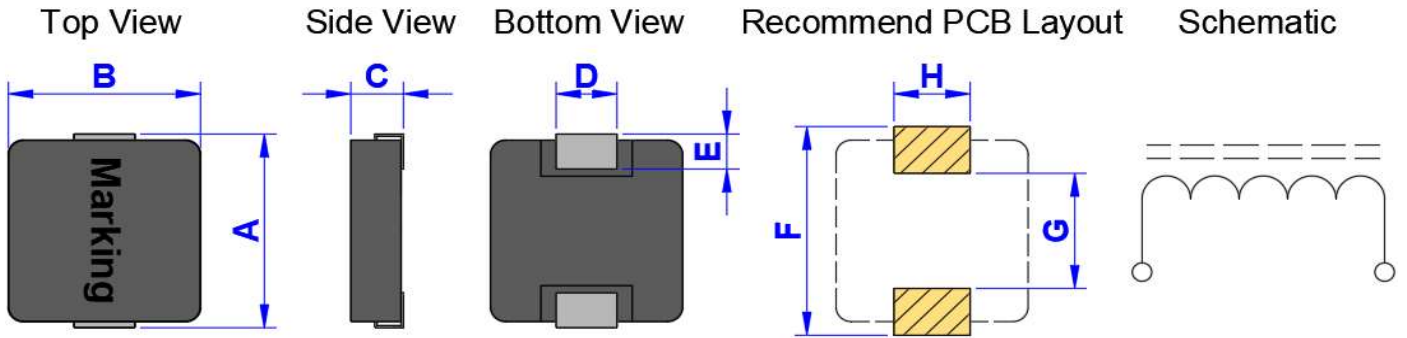

Marking : Inductance code

A(+/-0.2)	B(+/-0.2)	C(Max.)	D(+/-0.3)	E(+/-0.3)	F(Ref.)	G(Ref.)	H(Ref.)
5.7	5.2	2.0	2.0	1.5	6.0	2.2	2.5

Electrical Characteristics :

Part No.	Inductance (uH)	Inductance Tolerance	DCR (mΩ) (Max.)	Isat (Amp) (Typ.)	Irms (Amp) (Typ.)
GSTU5020PA-R22M	0.22	M	6.5	17.0	12.0
GSTU5020PA-R33M	0.33	M	8.0	15.0	11.0
GSTU5020PA-R47M	0.47	M	9.0	14.0	10.5
GSTU5020PA-R68M	0.68	M	13.0	12.0	8.5
GSTU5020PA-1R0M	1.00	M	17.0	8.0	7.0
GSTU5020PA-1R5M	1.50	M	35.0	6.5	5.5
GSTU5020PA-2R2M	2.20	M	45.0	6.0	4.0
GSTU5020PA-3R3M	3.30	M	60.0	5.0	3.5
GSTU5020PA-4R7M	4.70	M	90.0	5.0	3.0
GSTU5020PA-5R6M	5.60	M	120.0	4.5	2.8
GSTU5020PA-6R8M	6.80	M	125.0	3.4	2.8
GSTU5020PA-100M	10.00	M	180.0	3.0	2.3

* Test Condition : @100KHz , 1.0Vrms , 25°C Ambient

* Inductance Tolerance : M = +/-20%

* I_{rms} : Rated Current Loading when temperature rise approximately 40°C.

* I_{sat} : Saturated Current measured at the point of L drop approximately 30%.

* Absolute maximum voltage : 30VDC.

Typical Performance Curves :

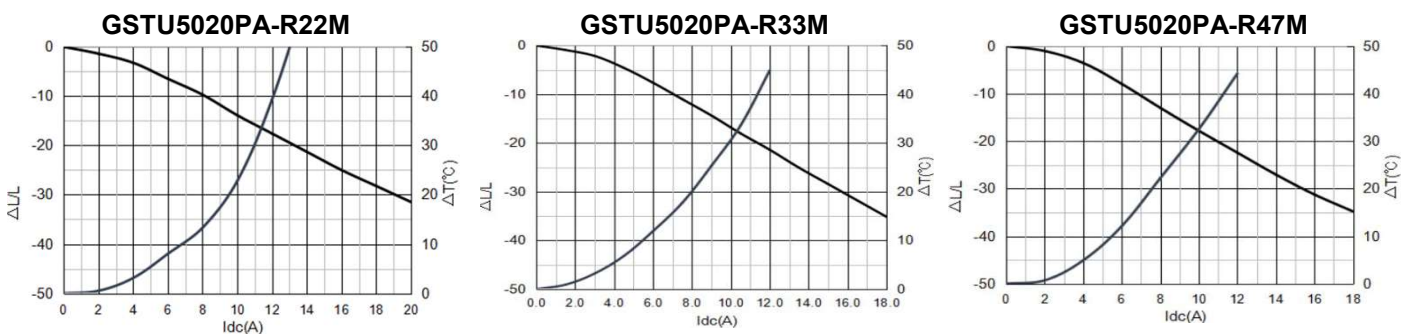

Product Series : GSTU
File Version : GSTU-SERIES
Established Date 2025.03.27
Latest Edit Date : 2025.04.01

Brand : GOTREND
Editor : Yinghui Guo
Description : High Current Inductor
Product Type : Standard Customize

GSTU5020PA-SERIES

Typical Performance Curves :

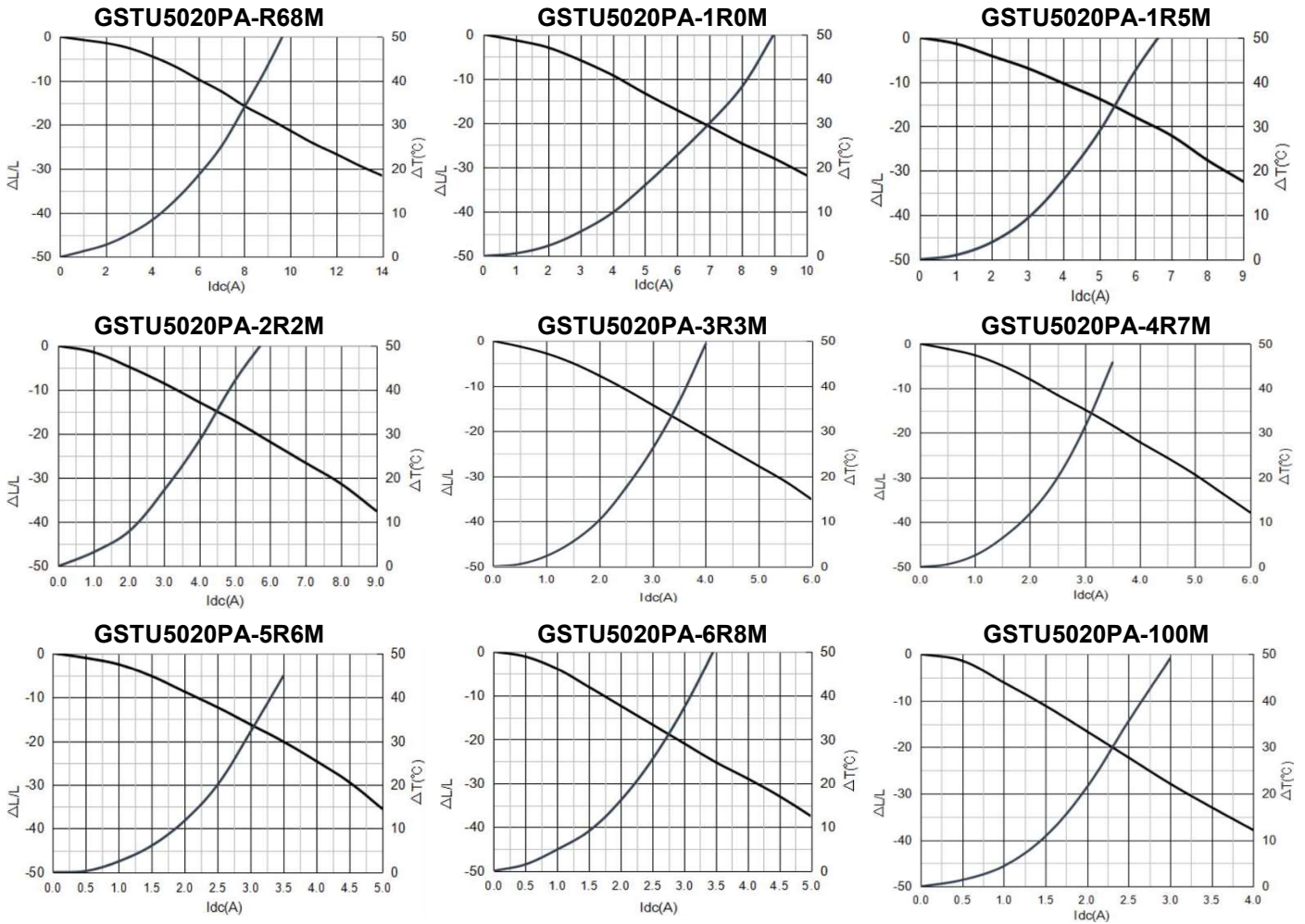

Product Series : GSTU	Brand : GOTREND
File Version : GSTU-SERIES	Editor : Yinghui Guo
Established Date 2025.03.27	Description : High Current Inductor
Latest Edit Date : 2025.04.01	Product Type : <input checked="" type="checkbox"/> Standard <input type="checkbox"/> Customize

GSTU5030PA-SERIES

Dimension [mm] :

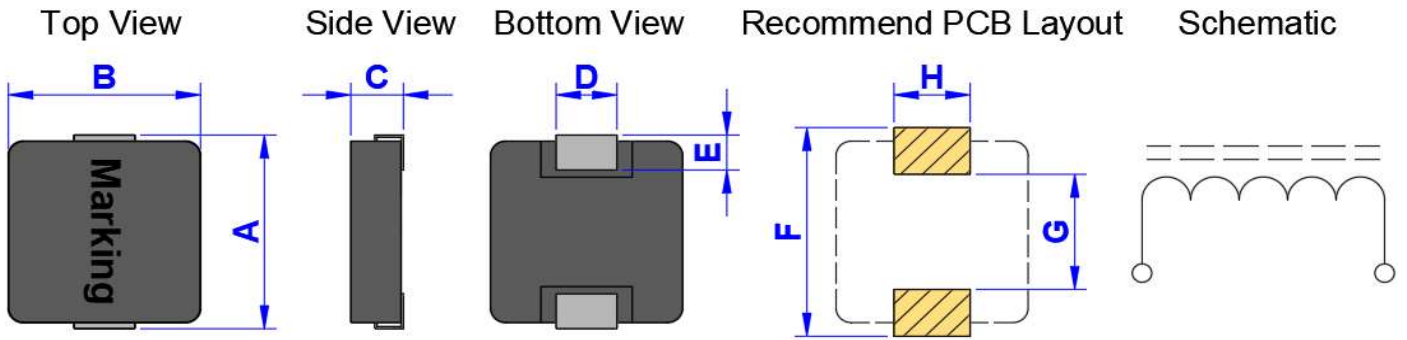

Marking : Inductance code

A(+/-0.2)	B(+/-0.35)	C(Max.)	D(+/-0.3)	E(+/-0.3)	F(Ref.)	G(Ref.)	H(Ref.)
5.7	5.4	3.0	2.0	1.5	6.0	2.2	2.5

Electrical Characteristics :

Part No.	Inductance (uH)	Inductance Tolerance	DCR (mΩ) (Max.)	Isat (Amp) (Typ.)	Irms (Amp) (Typ.)
GSTU5030PA-R22M	0.22	M	5.0	21.0	15.5
GSTU5030PA-R33M	0.33	M	7.0	15.0	10.0
GSTU5030PA-R47M	0.47	M	8.0	14.0	10.0
GSTU5030PA-R56M	0.56	M	10.0	14.0	9.0
GSTU5030PA-R68M	0.68	M	12.0	14.0	8.0
GSTU5030PA-R82M	0.82	M	13.0	12.0	7.5
GSTU5030PA-1R0M	1.00	M	15.0	11.0	7.0
GSTU5030PA-1R2M	1.20	M	16.0	11.0	6.5
GSTU5030PA-1R5M	1.50	M	25.0	10.0	6.0
GSTU5030PA-2R2M	2.20	M	35.0	8.0	5.0
GSTU5030PA-3R3M	3.30	M	46.0	7.0	4.5
GSTU5030PA-4R7M	4.70	M	60.0	6.0	4.0
GSTU5030PA-5R6M	5.60	M	65.0	4.5	4.0
GSTU5030PA-6R8M	6.80	M	110.0	5.0	3.0
GSTU5030PA-8R2M	8.20	M	110.0	4.5	2.8
GSTU5030PA-100M	10.00	M	126.0	4.5	2.5
GSTU5030PA-150M	15.00	M	180.0	2.5	2.1
GSTU5030PA-220M	22.00	M	270.0	2.0	2.0

* Test Condition : @100KHz , 1.0Vrms , 25°C Ambient

* Inductance Tolerance : M = +/-20%

* Irms : Rated Current Loading when temperature rise approximately 40°C.

* Isat : Saturated Current measured at the point of L drop approximately 30%.

* Absolute maximum voltage : 30VDC.

Typical Performance Curves :

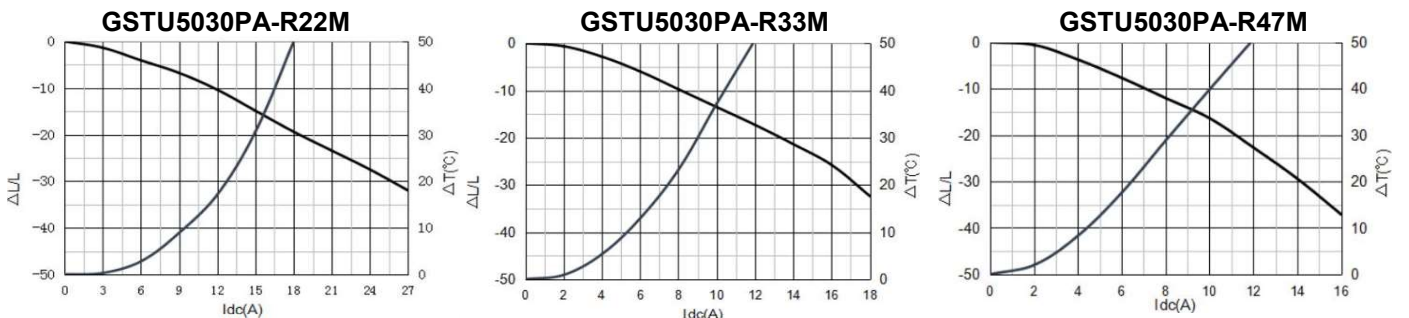

Product Series : GSTU
File Version : GSTU-SERIES
Established Date 2025.03.27
Latest Edit Date : 2025.04.01

Brand : GOTREND
Editor : Yinghui Guo
Description : High Current Inductor
Product Type : Standard Customize

GSTU5030PA-SERIES

Typical Performance Curves :

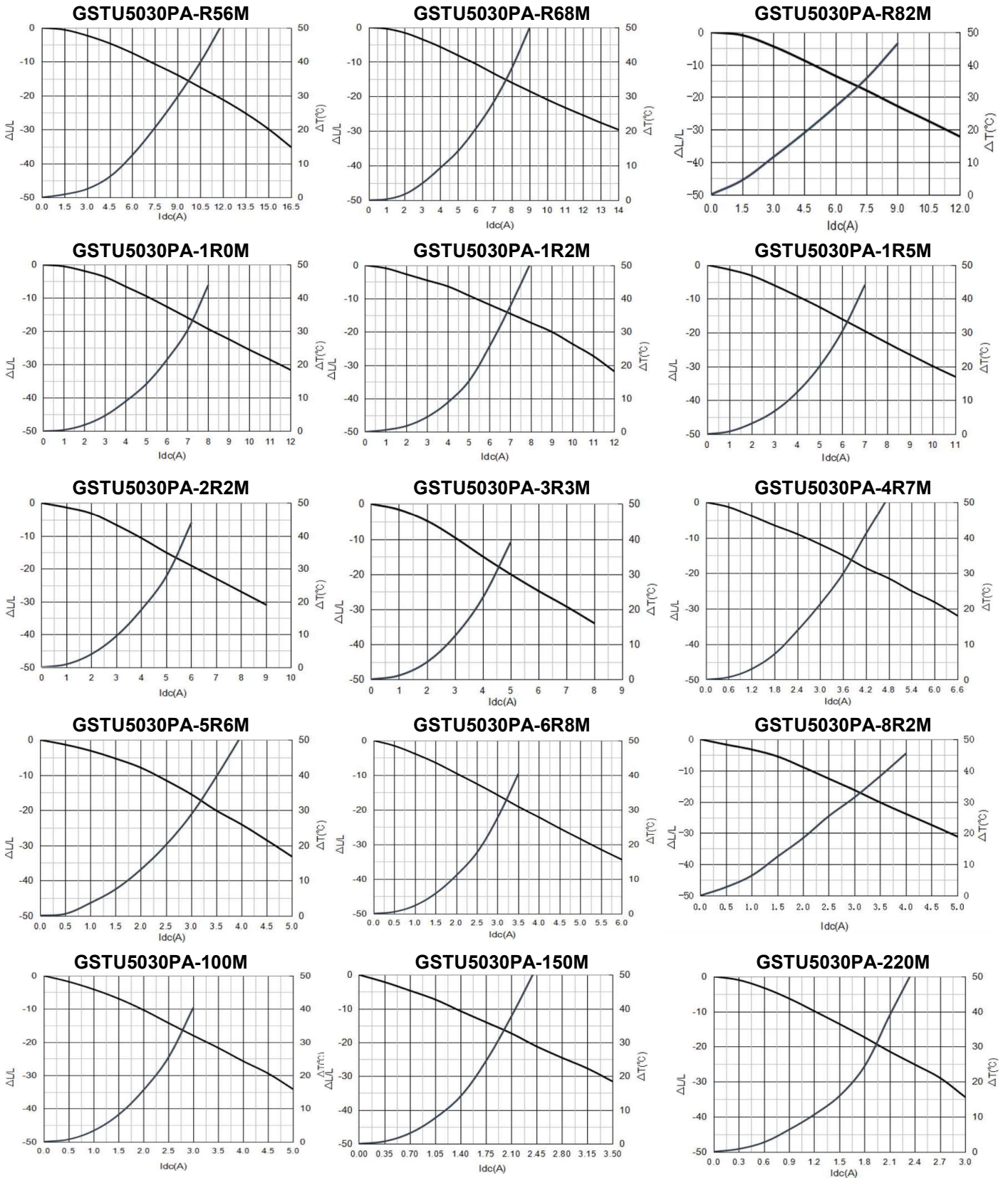

Product Series : GSTU	Brand : GOTREND
File Version : GSTU-SERIES	Editor : Yinghui Guo
Established Date : 2025.03.27	Description : High Current Inductor
Latest Edit Date : 2025.04.01	Product Type : <input checked="" type="checkbox"/> Standard <input type="checkbox"/> Customize

GSTU6018PA-SERIES

Dimension [mm] :

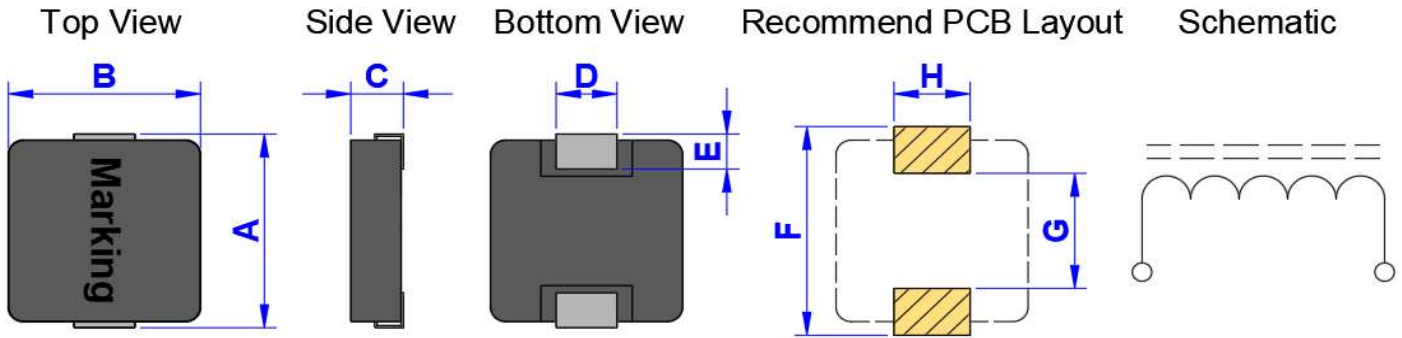

Marking : Inductance code

A(+/-0.3)	B(+/-0.3)	C(Max.)	D(+/-0.3)	E(+/-0.5)	F(Ref.)	G(Ref.)	H(Ref.)
7.1	6.6	1.8	3.0	1.6	8.4	3.7	3.5

Electrical Characteristics :

Part No.	Inductance (uH)	Inductance Tolerance	DCR (mΩ) (Max.)	Isat (Amp) (Typ.)	Irms (Amp) (Typ.)
GSTU6018PA-R22M	0.22	M	5.2	29.0	14.0
GSTU6018PA-R33M	0.33	M	6.8	22.0	12.0
GSTU6018PA-R47M	0.47	M	8.4	18.0	11.0
GSTU6018PA-R68M	0.68	M	12.7	17.0	9.0
GSTU6018PA-1R0M	1.00	M	20.0	14.0	7.0
GSTU6018PA-1R5M	1.50	M	26.0	12.0	6.5
GSTU6018PA-2R2M	2.20	M	35.0	8.0	5.0
GSTU6018PA-3R3M	3.30	M	55.0	6.5	4.5
GSTU6018PA-4R7M	4.70	M	70.0	5.0	3.5
GSTU6018PA-6R8M	6.80	M	110.0	4.0	2.8
GSTU6018PA-100M	10.00	M	165.0	2.5	2.3

- * Test Condition : @100KHz , 1.0Vrms , 25°C Ambient
- * Inductance Tolerance : M = +/-20%
- * I_{rms} : Rated Current Loading when temperature rise approximately 40°C.
- * I_{sat} : Saturated Current measured at the point of L drop approximately 30%.
- * Absolute maximum voltage : 30VDC.

Typical Performance Curves :

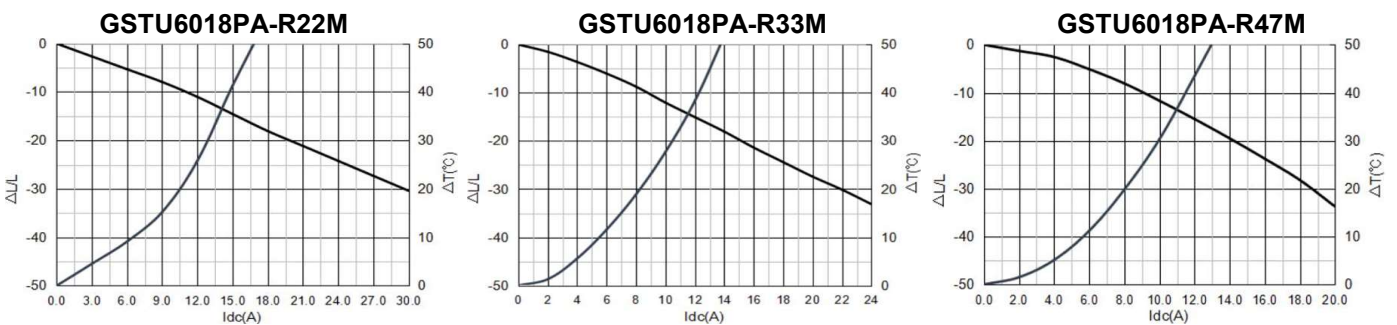

GSTU6018PA-SERIES

Typical Performance Curves :

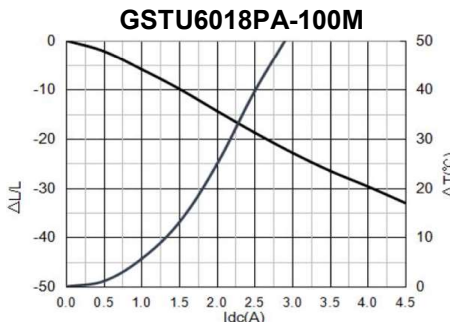
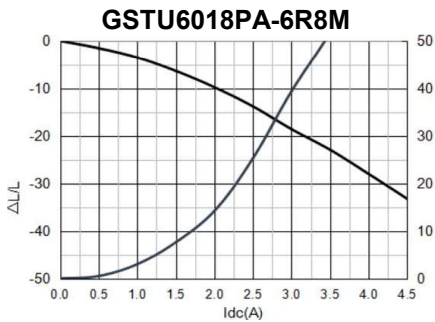
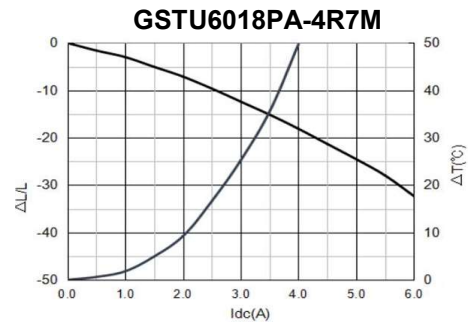
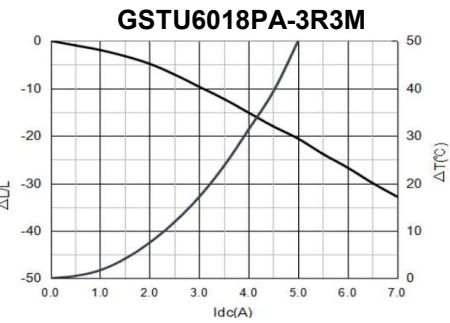
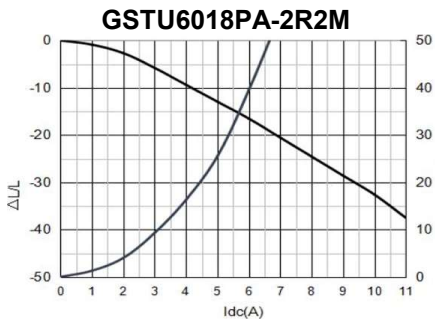
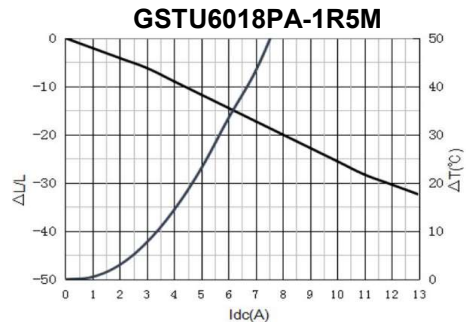
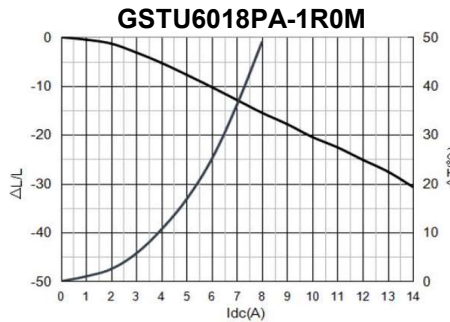
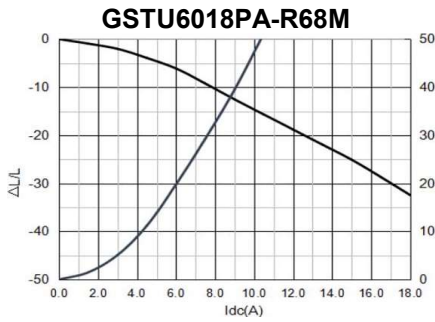

Product Series : GSTU	Brand : GOTREND
File Version : GSTU-SERIES	Editor : Yinghui Guo
Established Date : 2025.03.27	Description : High Current Inductor
Latest Edit Date : 2025.04.01	Product Type : <input checked="" type="checkbox"/> Standard <input type="checkbox"/> Customize

GSTU6020PA-SERIES

Dimension [mm] :

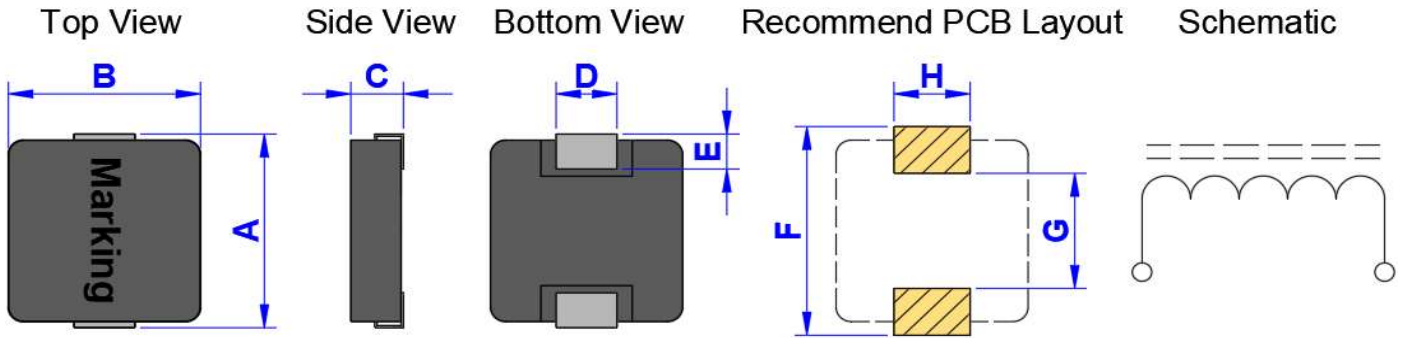

Marking : Inductance code

A(+/-0.3)	B(+/-0.3)	C(Max.)	D(+/-0.3)	E(+/-0.5)	F(Ref.)	G(Ref.)	H(Ref.)
7.1	6.6	2.0	3.0	1.6	8.4	3.7	3.5

Electrical Characteristics :

Part No.	Inductance (uH)	Inductance Tolerance	DCR (mΩ) (Max.)	Isat (Amp) (Typ.)	Irms (Amp) (Typ.)
GSTU6020PA-R47M	0.47	M	8.4	18.0	11.0
GSTU6020PA-R68M	0.68	M	12.0	17.0	10.5
GSTU6020PA-1R0M	1.00	M	17.0	14.0	9.5
GSTU6020PA-1R5M	1.50	M	20.0	10.0	7.0
GSTU6020PA-3R3M	3.30	M	55.0	7.5	5.0
GSTU6020PA-4R7M	4.70	M	60.0	5.0	3.5
GSTU6020PA-6R8M	6.80	M	105.0	4.2	3.0

* Test Condition : @100KHz , 1.0Vrms , 25°C Ambient

* Inductance Tolerance : M = +/-20%

* I_{rms} : Rated Current Loading when temperature rise approximately 40°C.

* I_{sat} : Saturated Current measured at the point of L drop approximately 30%.

* Absolute maximum voltage : 30VDC.

GSTU6020PA-SERIES

Typical Performance Curves :

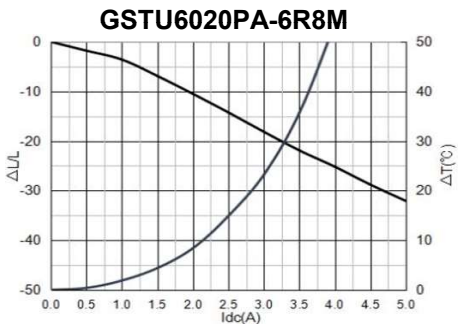
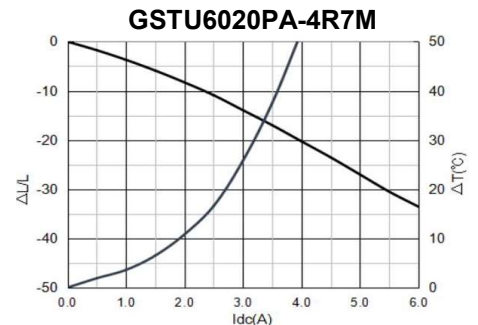
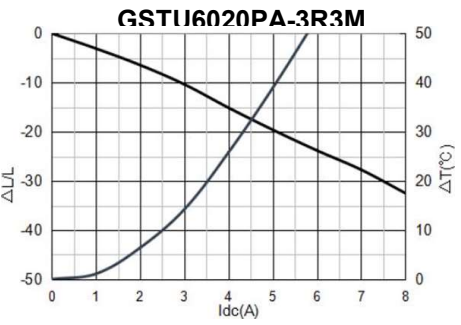
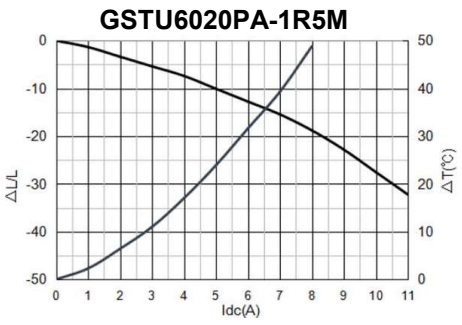
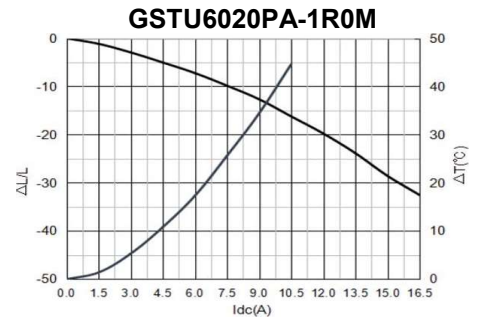
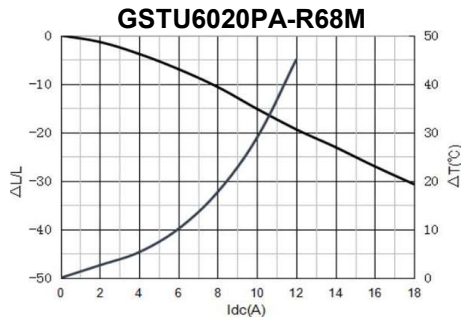
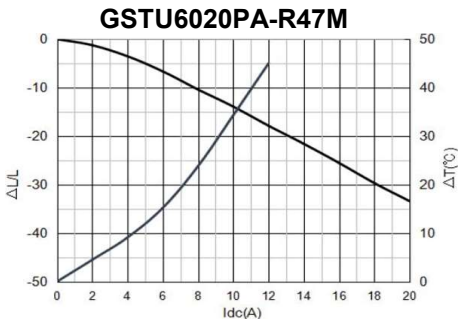

Product Series : GSTU	Brand : GOTREND
File Version : GSTU-SERIES	Editor : Yinghui Guo
Established Date : 2025.03.27	Description : High Current Inductor
Latest Edit Date : 2025.04.01	Product Type : <input checked="" type="checkbox"/> Standard <input type="checkbox"/> Customize

GSTU6024PA-SERIES

Dimension [mm] :

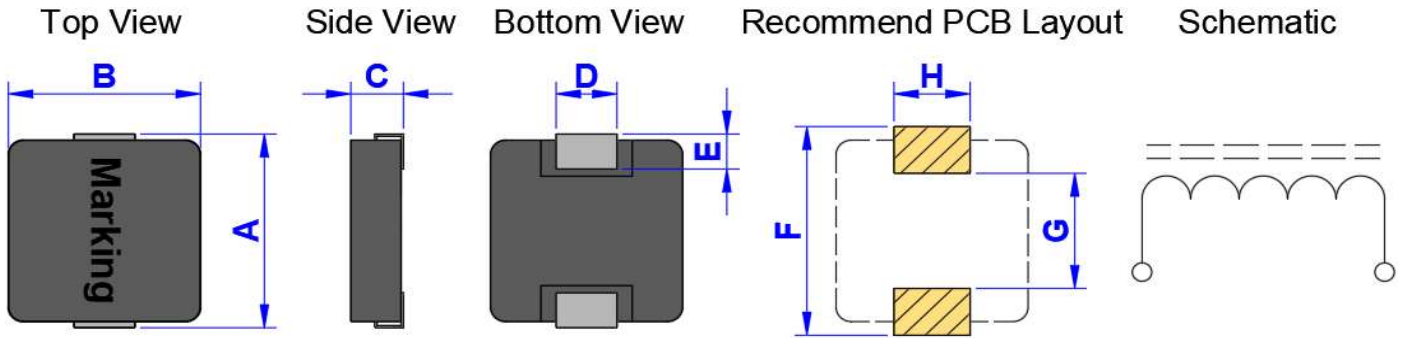

Marking : Inductance code

A(+/-0.3)	B(+/-0.3)	C(Max.)	D(+/-0.3)	E(+/-0.5)	F(Ref.)	G(Ref.)	H(Ref.)
7.1	6.6	2.4	3.0	1.6	8.4	3.7	3.5

Electrical Characteristics :

Part No.	Inductance (uH)	Inductance Tolerance	DCR (mΩ) (Max.)	Isat (Amp) (Typ.)	Irms (Amp) (Typ.)
GSTU6024PA-R22M	0.22	M	3.5	30.0	16.0
GSTU6024PA-R47M	0.47	M	6.5	22.0	15.0
GSTU6024PA-R68M	0.68	M	9.4	18.0	11.0
GSTU6024PA-1R0M	1.00	M	13.5	16.0	9.0
GSTU6024PA-1R5M	1.50	M	20.0	15.0	8.0
GSTU6024PA-2R2M	2.20	M	28.0	11.0	6.0
GSTU6024PA-3R3M	3.30	M	39.0	10.0	5.5
GSTU6024PA-4R7M	4.70	M	50.0	7.0	5.0
GSTU6024PA-6R8M	6.80	M	70.0	6.0	4.0
GSTU6024PA-8R2M	8.20	M	95.0	5.0	3.5
GSTU6024PA-100M	10.00	M	101.0	4.0	3.1
GSTU6024PA-150M	15.00	M	160.0	3.3	2.5

* Test Condition : @100KHz , 1.0Vrms , 25°C Ambient

* Inductance Tolerance : M = +/-20%

* I_{rms} : Rated Current Loading when temperature rise approximately 40°C.

* I_{sat} : Saturated Current measured at the point of L drop approximately 30%.

* Absolute maximum voltage : 30VDC.

Typical Performance Curves :

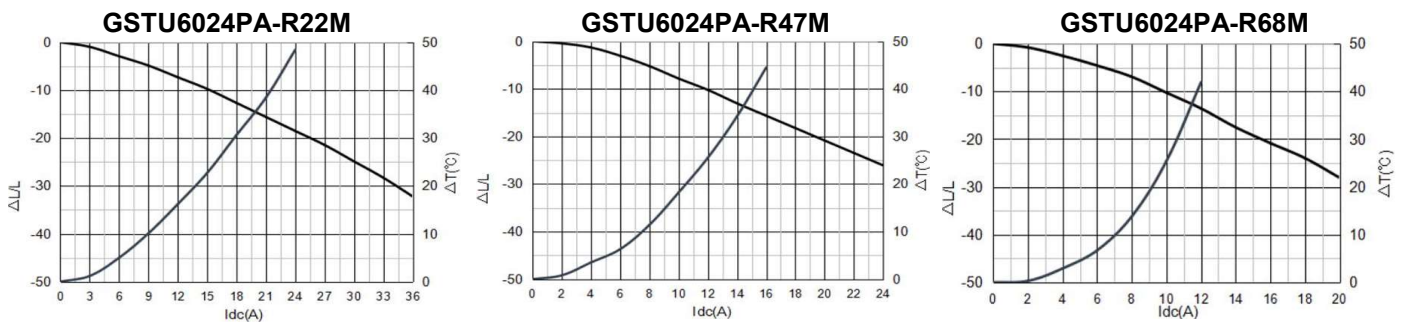

GSTU6024PA-SERIES

Typical Performance Curves :

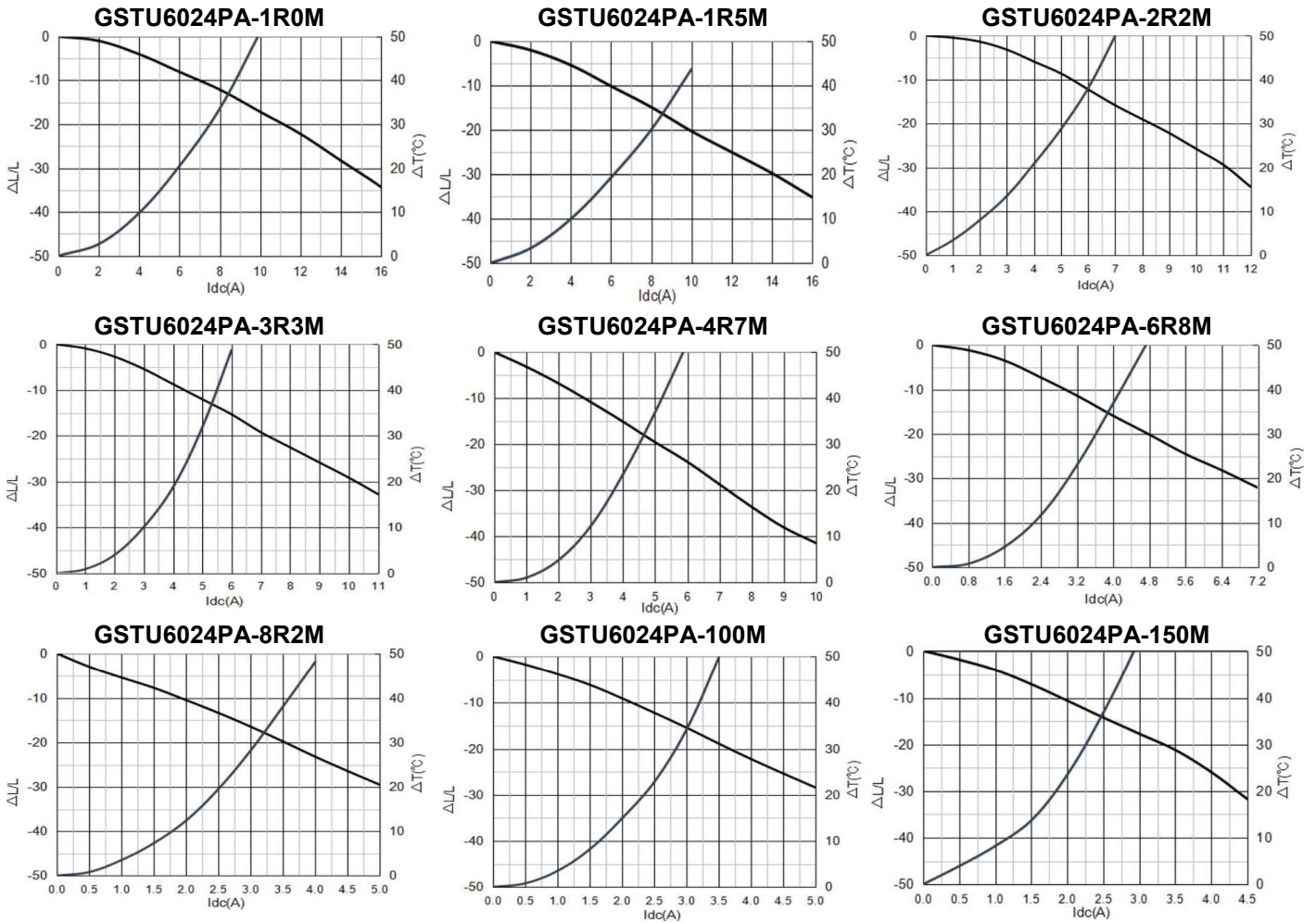

Product Series : GSTU	Brand : GOTREND
File Version : GSTU-SERIES	Editor : Yinghui Guo
Established Date : 2025.03.27	Description : High Current Inductor
Latest Edit Date : 2025.04.01	Product Type : <input checked="" type="checkbox"/> Standard <input type="checkbox"/> Customize

GSTU6030PA-SERIES

Dimension [mm] :

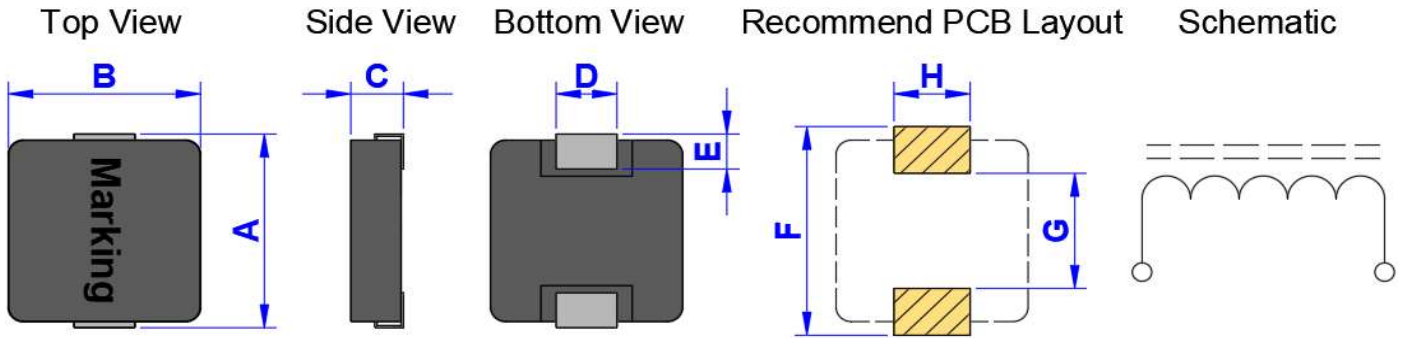

Marking : Inductance code

A(+/-0.3)	B(+/-0.3)	C(Max.)	D(+/-0.3)	E(+/-0.5)	F(Ref.)	G(Ref.)	H(Ref.)
7.1	6.6	3.0	3.0	1.6	8.4	3.7	3.5

Electrical Characteristics :

Part No.	Inductance (uH)	Inductance Tolerance	DCR (mΩ) (Max.)	Isat (Amp) (Typ.)	Irms (Amp) (Typ.)
GSTU6030PA-R22M	0.22	M	2.8	40.0	23.0
GSTU6030PA-R33M	0.33	M	4.2	30.0	20.0
GSTU6030PA-R47M	0.47	M	5.5	27.0	14.0
GSTU6030PA-R68M	0.68	M	6.3	24.0	13.0
GSTU6030PA-R82M	0.82	M	8.0	23.0	12.5
GSTU6030PA-1R0M	1.00	M	10.0	22.0	12.0
GSTU6030PA-1R5M	1.50	M	15.0	18.0	9.5
GSTU6030PA-2R2M	2.20	M	20.0	14.0	8.5
GSTU6030PA-3R3M	3.30	M	35.0	12.0	6.0
GSTU6030PA-4R7M	4.70	M	40.0	9.0	5.5
GSTU6030PA-5R6M	5.60	M	40.0	8.0	5.5
GSTU6030PA-6R8M	6.80	M	60.0	7.0	4.5
GSTU6030PA-8R2M	8.20	M	60.0	6.0	4.5
GSTU6030PA-100M	10.00	M	68.0	5.5	4.0
GSTU6030PA-150M	15.00	M	122.0	5.0	3.0
GSTU6030PA-220M	22.00	M	145.0	3.2	3.0
GSTU6030PA-330M	33.00	M	270.0	3.0	2.0

* Test Condition : @100KHz , 1.0Vrms , 25°C Ambient

* Inductance Tolerance : M = +/-20%

* I_{rms} : Rated Current Loading when temperature rise approximately 40°C.

* I_{sat} : Saturated Current measured at the point of L drop approximately 30%.

* Absolute maximum voltage : 30VDC.

Typical Performance Curves :

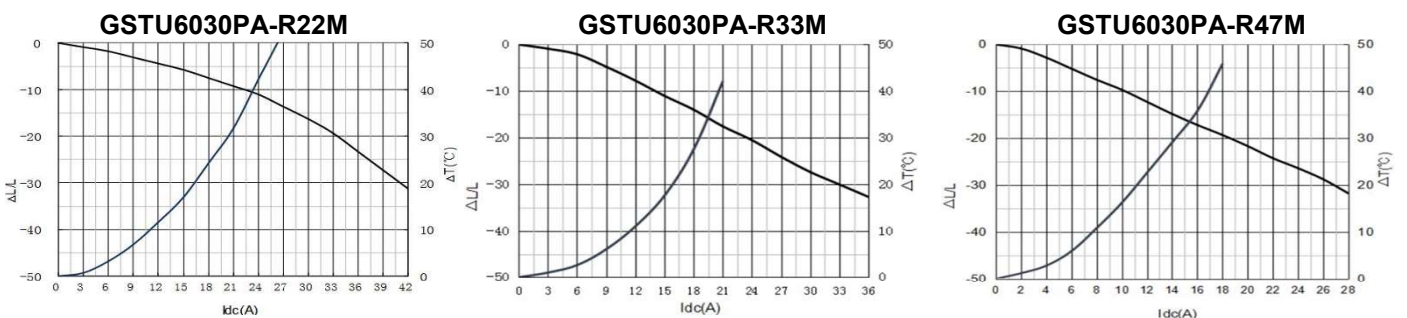

GSTU6030PA-SERIES

Typical Performance Curves :

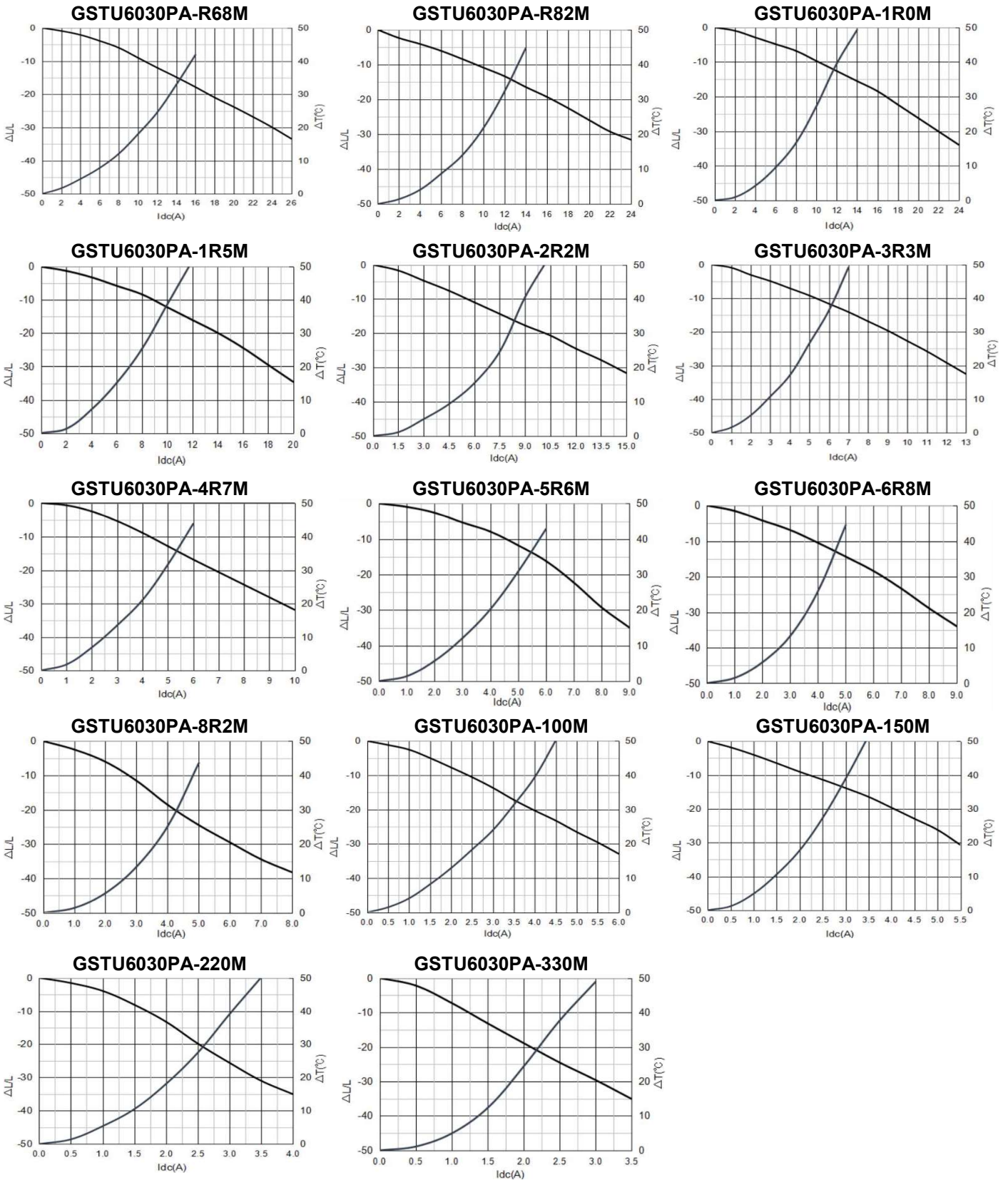

Product Series : GSTU	Brand : GOTREND
File Version : GSTU-SERIES	Editor : Yinghui Guo
Established Date : 2025.03.27	Description : High Current Inductor
Latest Edit Date : 2025.04.01	Product Type : <input checked="" type="checkbox"/> Standard <input type="checkbox"/> Customize

GSTU6040PA-SERIES

Dimension [mm] :

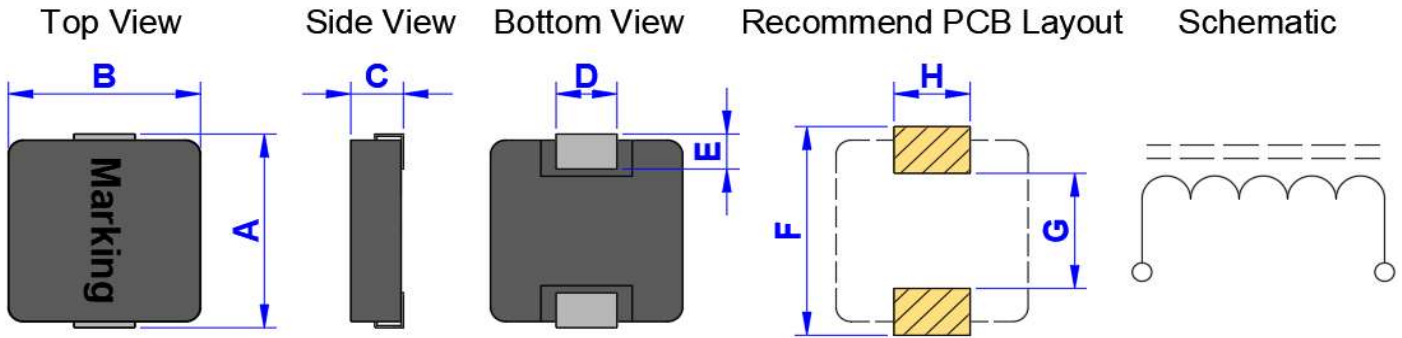

Marking : Inductance code

A(+/-0.3)	B(+/-0.3)	C(Max.)	D(+/-0.3)	E(+/-0.5)	F(Ref.)	G(Ref.)	H(Ref.)
7.1	6.6	4.0	3.0	1.6	8.4	3.7	3.5

Electrical Characteristics :

Part No.	Inductance (uH)	Inductance Tolerance	DCR (mΩ) (Max.)	Isat (Amp) (Typ.)	Irms (Amp) (Typ.)
GSTU6040PA-R33M	0.33	M	3.5	30.0	20.0
GSTU6040PA-R68M	0.68	M	4.8	20.0	16.0
GSTU6040PA-1R0M	1.00	M	8.0	18.0	12.5
GSTU6040PA-1R5M	1.50	M	14.0	16.0	10.0
GSTU6040PA-2R2M	2.20	M	18.0	12.0	9.0
GSTU6040PA-3R3M	3.30	M	25.0	10.0	7.0
GSTU6040PA-4R7M	4.70	M	35.0	8.0	6.0
GSTU6040PA-6R8M	6.80	M	50.0	7.0	5.0
GSTU6040PA-100M	10.00	M	62.0	5.0	4.5
GSTU6040PA-150M	15.00	M	95.0	4.5	3.5
GSTU6040PA-220M	22.00	M	125.0	4.0	3.0
GSTU6040PA-330M	33.00	M	220.0	3.2	2.5
GSTU6040PA-470M	47.00	M	280.0	2.5	2.1

* Test Condition : @100KHz , 1.0Vrms , 25°C Ambient

* Inductance Tolerance : M = +/-20%

* I_{rms} : Rated Current Loading when temperature rise approximately 40°C.

* I_{sat} : Saturated Current measured at the point of L drop approximately 30%.

* Absolute maximum voltage : 30VDC.

Typical Performance Curves :

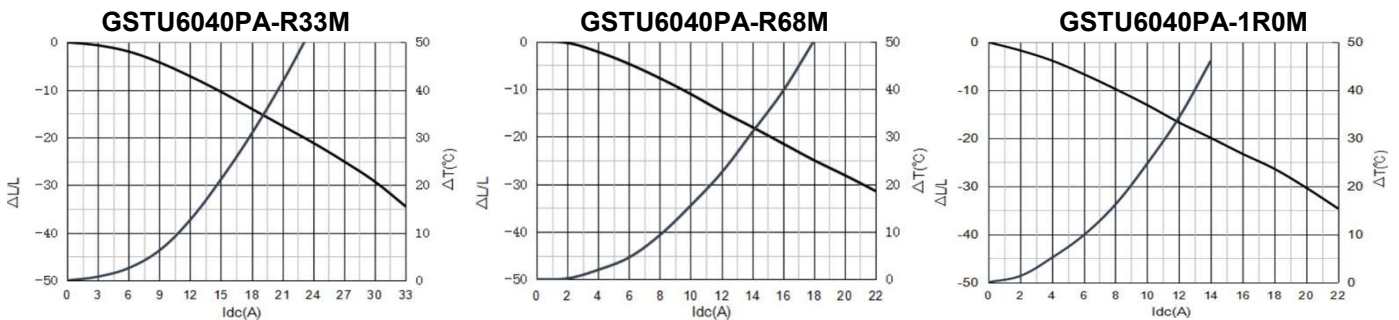

GSTU6040PA-SERIES

Typical Performance Curves :

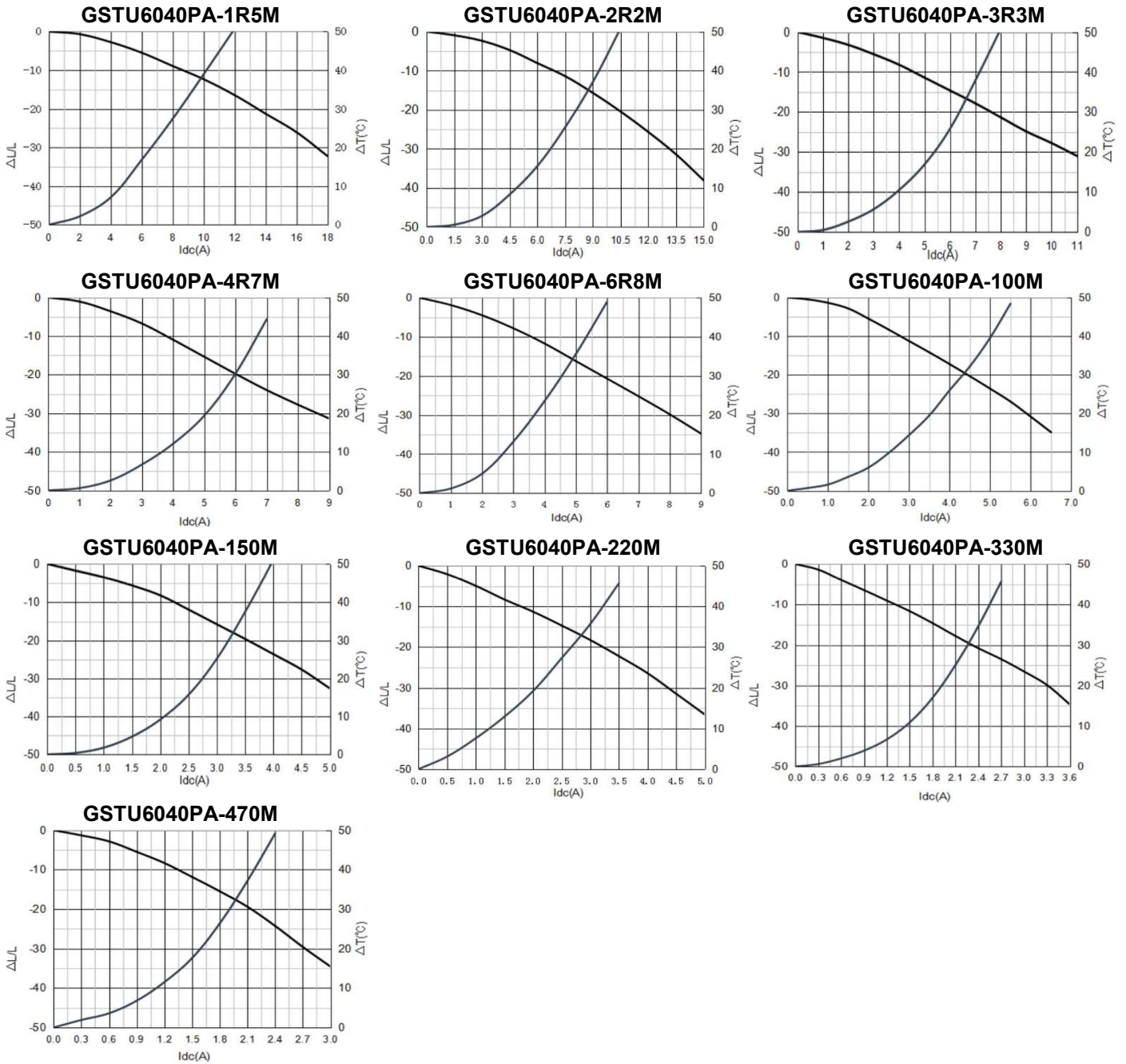

Product Series : GSTU	Brand : GOTREND
File Version : GSTU-SERIES	Editor : Yinghui Guo
Established Date : 2025.03.27	Description : High Current Inductor
Latest Edit Date : 2025.04.01	Product Type : <input checked="" type="checkbox"/> Standard <input type="checkbox"/> Customize

GSTU6050PA-SERIES

Dimension [mm] :

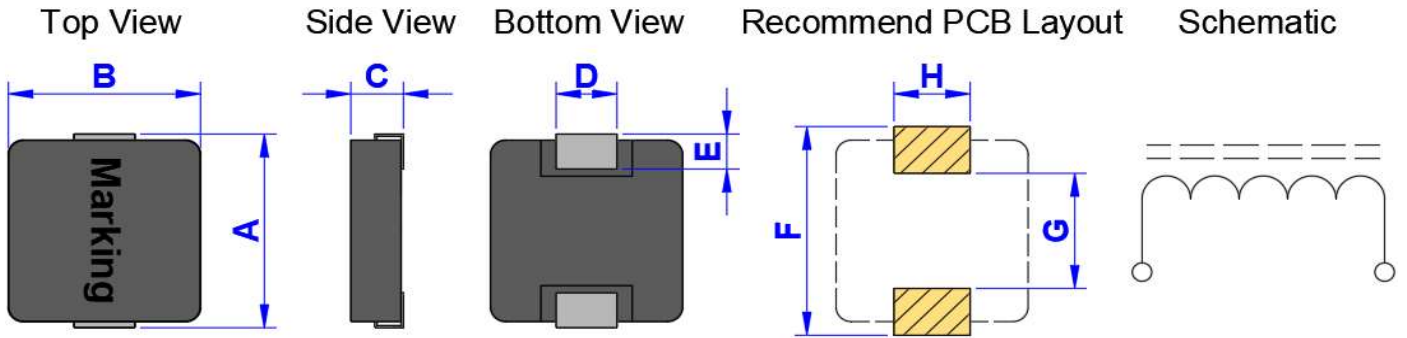

Marking : Inductance code

A(+/-0.3)	B(+/-0.3)	C(Max.)	D(+/-0.3)	E(+/-0.5)	F(Ref.)	G(Ref.)	H(Ref.)
7.1	6.6	5.0	3.0	1.6	8.4	3.7	3.5

Electrical Characteristics :

Part No.	Inductance (uH)	Inductance Tolerance	DCR (mΩ) (Max.)	Isat (Amp) (Typ.)	Irms (Amp) (Typ.)
GSTU6050PA-R36M	0.36	M	4.0	23.0	15.0
GSTU6050PA-R47M	0.47	M	4.2	21.0	14.0
GSTU6050PA-R68M	0.68	M	4.5	18.0	13.0
GSTU6050PA-R82M	0.82	M	5.5	17.0	12.5
GSTU6050PA-1R0M	1.00	M	6.5	13.0	12.0
GSTU6050PA-1R5M	1.50	M	8.5	10.0	10.0
GSTU6050PA-2R2M	2.20	M	12.5	9.5	9.5
GSTU6050PA-3R3M	3.30	M	20.9	9.0	8.5
GSTU6050PA-4R7M	4.70	M	27.0	8.0	6.5
GSTU6050PA-5R6M	5.60	M	35.0	7.0	6.0
GSTU6050PA-6R8M	6.80	M	38.0	7.0	5.5
GSTU6050PA-8R2M	8.20	M	45.0	6.5	5.0
GSTU6050PA-100M	10.00	M	55.0	6.0	4.5
GSTU6050PA-150M	15.00	M	85.0	4.0	3.1
GSTU6050PA-220M	22.00	M	130.0	3.5	2.6
GSTU6050PA-330M	33.00	M	200.0	3.0	2.3
GSTU6050PA-470M	47.00	M	290.0	2.8	2.0

- * Test Condition : @100KHz , 1.0Vrms , 25°C Ambient
- * Inductance Tolerance : M = +/-20%
- * I_{rms} : Rated Current Loading when temperature rise approximately 40°C.
- * I_{sat} : Saturated Current measured at the point of L drop approximately 30%.
- * Absolute maximum voltage : 30VDC.

Typical Performance Curves :

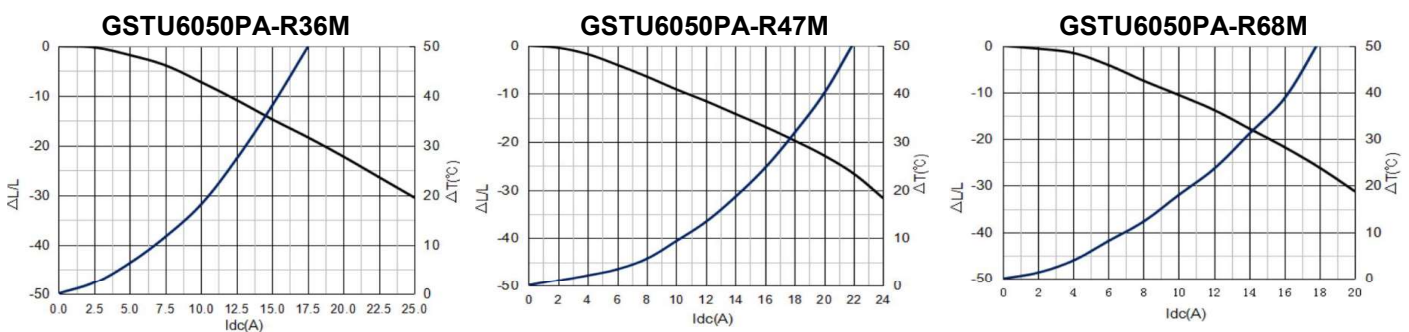

GSTU6050PA-SERIES

Typical Performance Curves :

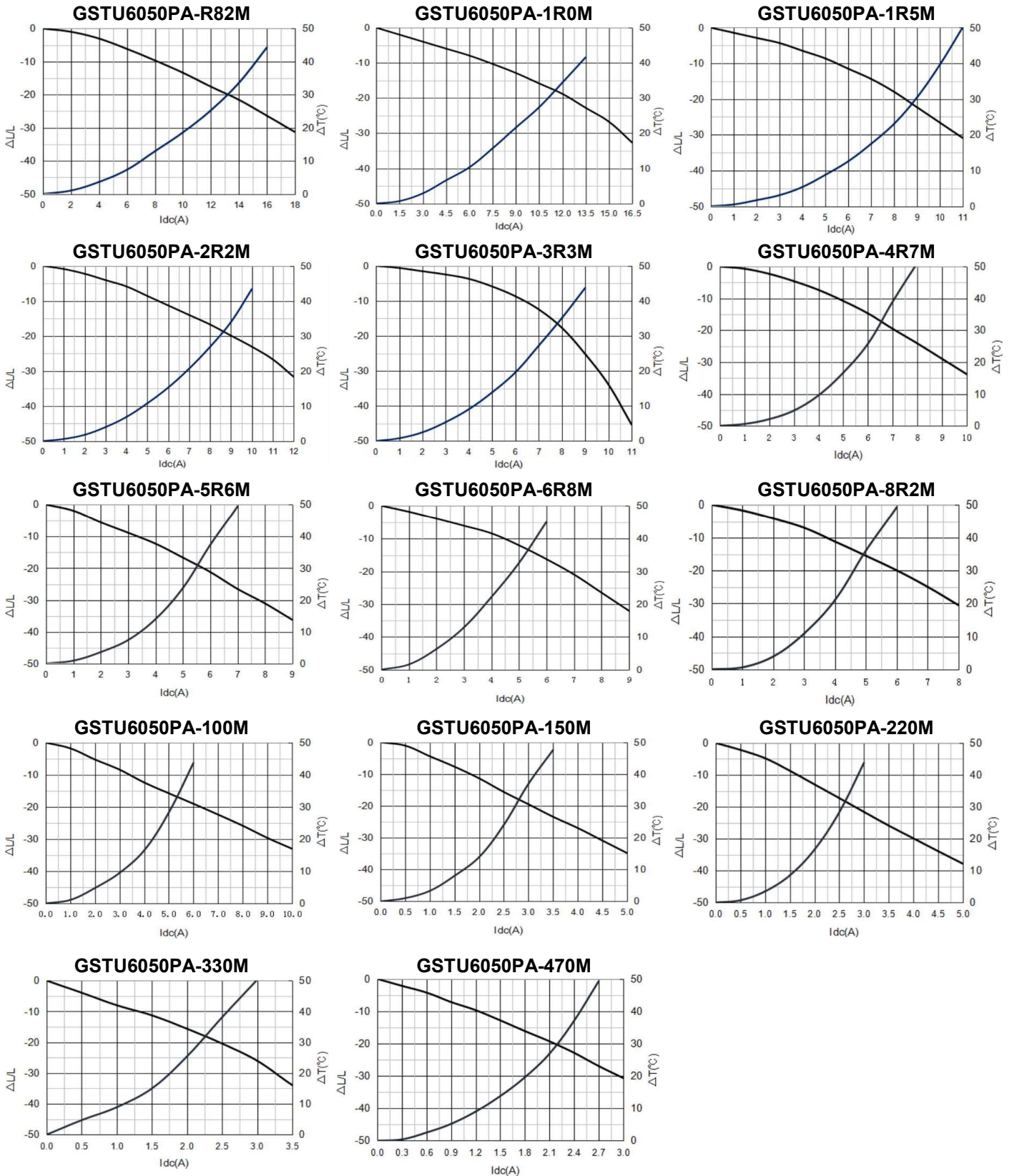

Product Series : GSTU	Brand : GOTREND
File Version : GSTU-SERIES	Editor : Yinghui Guo
Established Date : 2025.03.27	Description : High Current Inductor
Latest Edit Date : 2025.04.01	Product Type : <input checked="" type="checkbox"/> Standard <input type="checkbox"/> Customize

GSTU8040PA-SERIES

Dimension [mm] :

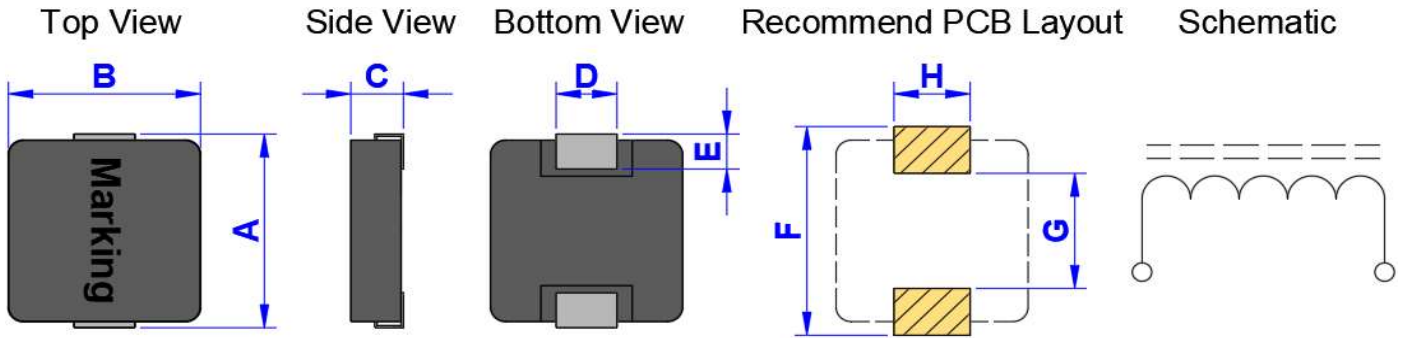

Marking : Inductance code

A(+/-0.3)	B(+/-0.2)	C(Max.)	D(+/-0.2)	E(+/-0.3)	F(Ref.)	G(Ref.)	H(Ref.)
8.7	8.1	4.0	3.0	2.0	9.0	4.7	3.2

Electrical Characteristics :

Part No.	Inductance (uH)	Inductance Tolerance	DCR (mΩ) (Max.)	Isat (Amp) (Typ.)	Irms (Amp) (Typ.)
GSTU8040PA-R82M	0.82	M	4.0	22.0	18.0
GSTU8040PA-2R2M	2.20	M	10.0	15.0	12.0
GSTU8040PA-3R3M	3.30	M	14.9	12.0	10.5
GSTU8040PA-4R7M	4.70	M	22.6	10.0	8.0
GSTU8040PA-6R8M	6.80	M	33.4	9.0	6.5
GSTU8040PA-100M	10.00	M	51.8	7.0	5.5
GSTU8040PA-150M	15.00	M	65.3	5.0	4.5
GSTU8040PA-220M	22.00	M	100.0	4.5	4.0
GSTU8040PA-330M	33.00	M	144.0	3.5	3.2
GSTU8040PA-470M	47.00	M	180.0	2.8	2.5

- * Test Condition : @100KHz , 1.0Vrms , 25°C Ambient
- * Inductance Tolerance : M = +/-20%
- * I_{rms} : Rated Current Loading when temperature rise approximately 40°C.
- * I_{sat} : Saturated Current measured at the point of L drop approximately 30%.
- * Absolute maximum voltage : 30VDC.

Typical Performance Curves :

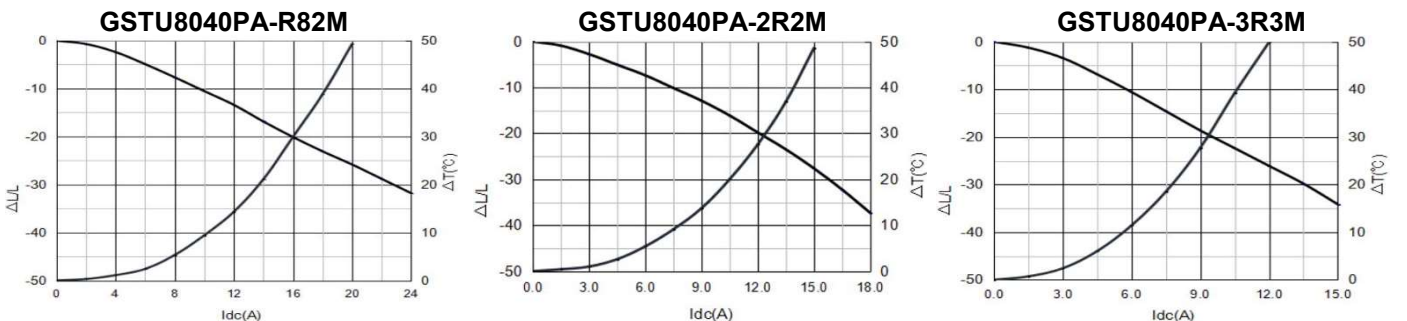

GSTU8040PA-SERIES

Typical Performance Curves :

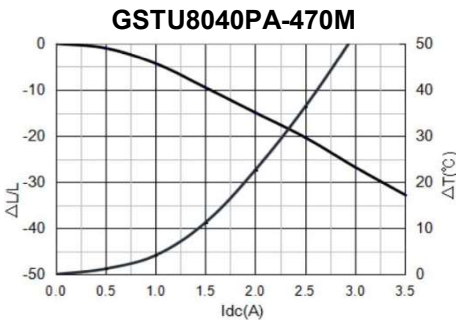
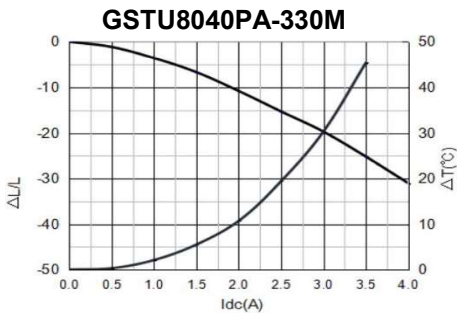
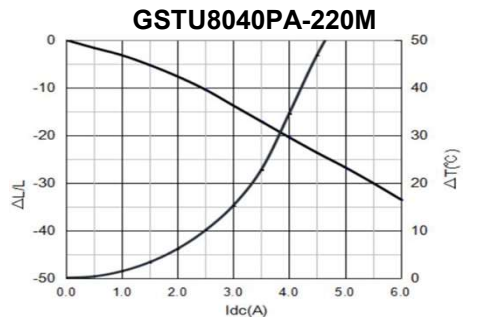
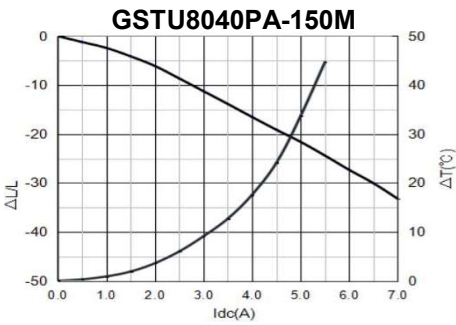
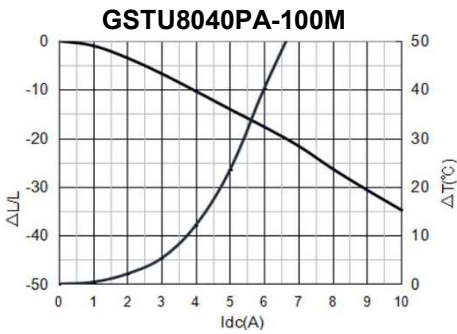
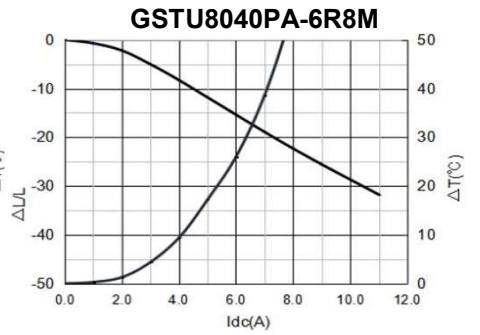
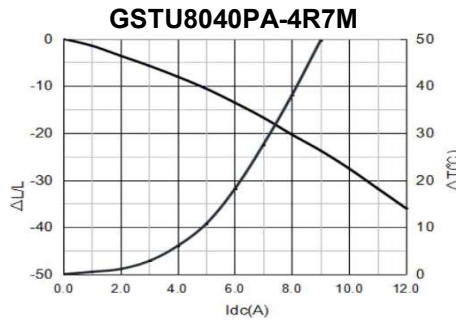
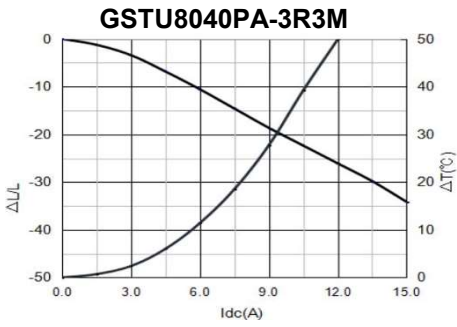

Product Series : GSTU	Brand : GOTREND
File Version : GSTU-SERIES	Editor : Yinghui Guo
Established Date : 2025.03.27	Description : High Current Inductor
Latest Edit Date : 2025.04.01	Product Type : <input checked="" type="checkbox"/> Standard <input type="checkbox"/> Customize

GSTU8050PA-SERIES

Dimension [mm] :

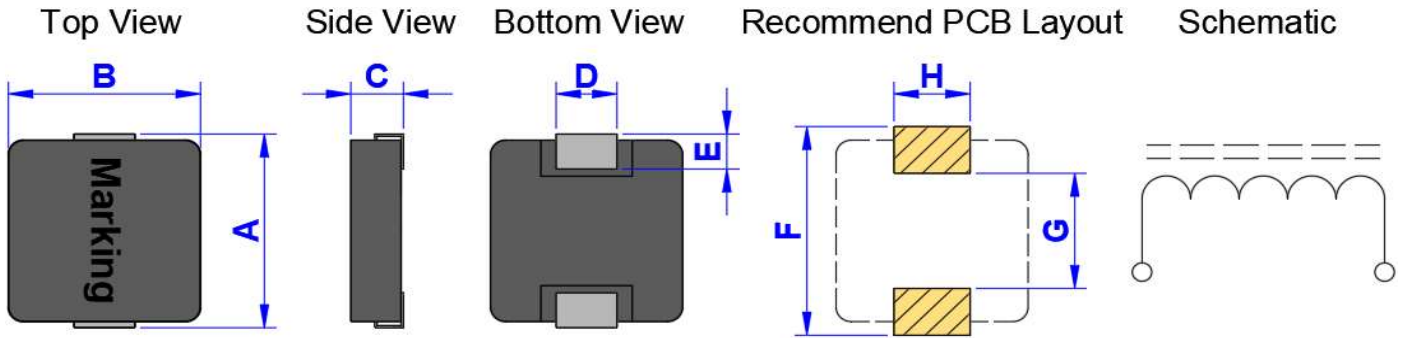

Marking : Inductance code

A(+/-0.3)	B(+/-0.2)	C(Max.)	D(+/-0.2)	E(+/-0.3)	F(Ref.)	G(Ref.)	H(Ref.)
8.7	8.1	5.0	3.0	2.0	9.0	4.7	3.2

Electrical Characteristics :

Part No.	Inductance (uH)	Inductance Tolerance	DCR (mΩ) (Max.)	Isat (Amp) (Typ.)	Irms (Amp) (Typ.)
GSTU8050PA-1R0M	1.00	M	5.5	18.0	16.0
GSTU8050PA-1R5M	1.50	M	6.0	16.0	13.0
GSTU8050PA-2R2M	2.20	M	13.0	15.0	10.0
GSTU8050PA-3R3M	3.30	M	18.0	13.0	8.0
GSTU8050PA-4R7M	4.70	M	22.0	11.0	7.5
GSTU8050PA-6R8M	6.80	M	25.0	10.0	7.0
GSTU8050PA-100M	10.00	M	45.0	8.0	6.0
GSTU8050PA-150M	15.00	M	60.0	5.5	5.0
GSTU8050PA-220M	22.00	M	90.0	5.0	4.0
GSTU8050PA-330M	33.00	M	130.0	4.0	3.3
GSTU8050PA-470M	47.00	M	200.0	3.5	2.5
GSTU8050PA-680M	68.00	M	300.0	3.0	2.0

- * **Test Condition :** @100KHz , 1.0Vrms , 25°C Ambient
- * **Inductance Tolerance :** M = +/-20%
- * **Irms :** Rated Current Loading when temperature rise approximately 40°C.
- * **Isat :** Saturated Current measured at the point of L drop approximately 30%.
- * **Absolute maximum voltage :** 30VDC.

Typical Performance Curves :

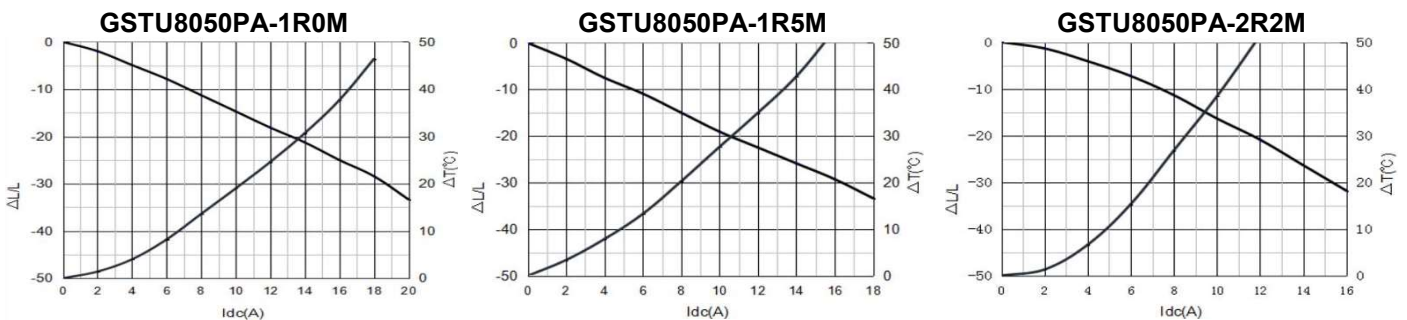

GSTU8050PA-SERIES

Typical Performance Curves :

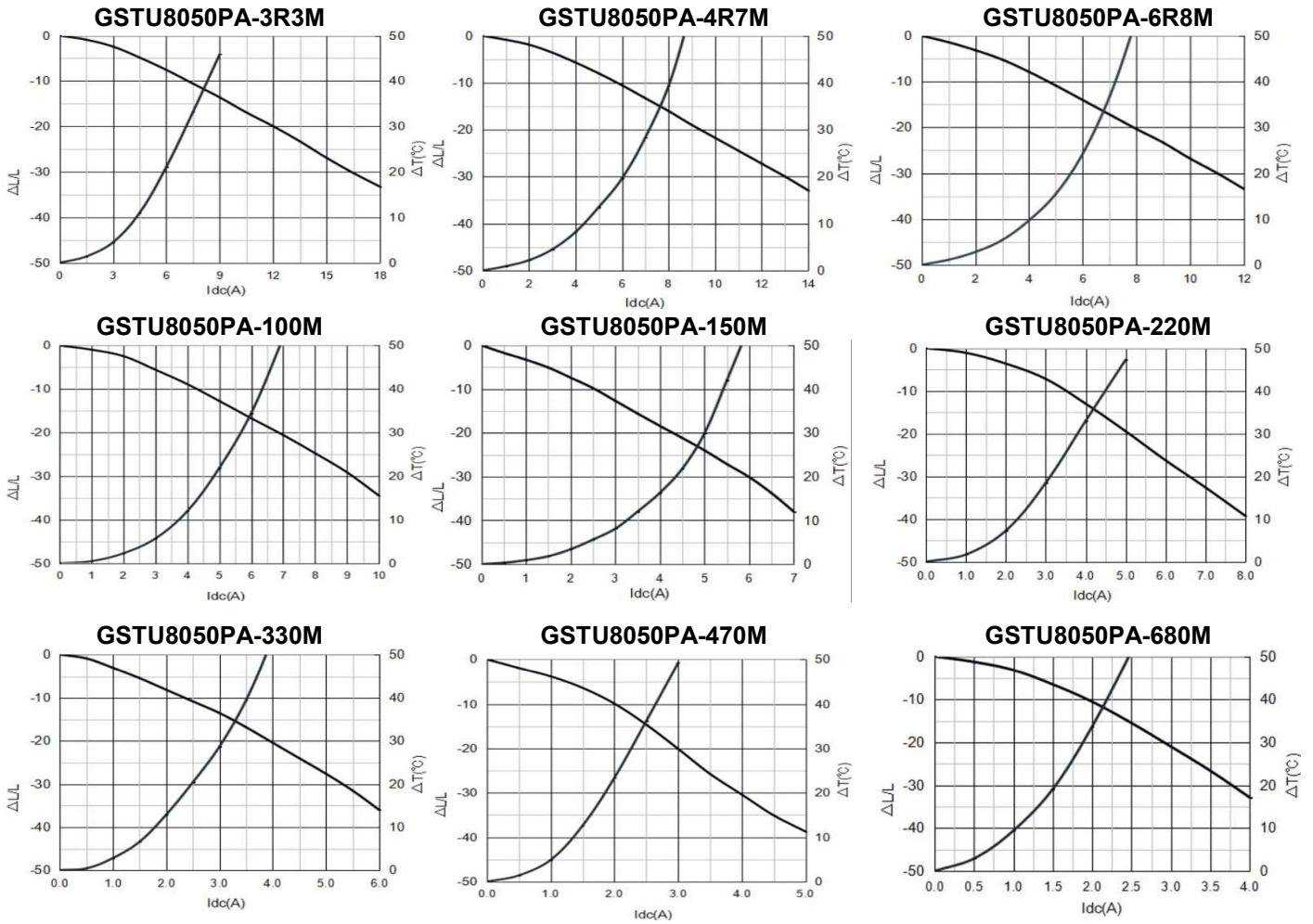

Product Series : GSTU	Brand : GOTREND
File Version : GSTU-SERIES	Editor : Yinghui Guo
Established Date : 2025.03.27	Description : High Current Inductor
Latest Edit Date : 2025.04.01	Product Type : <input checked="" type="checkbox"/> Standard <input type="checkbox"/> Customize

GSTU1040PA-SERIES

Dimension [mm] :

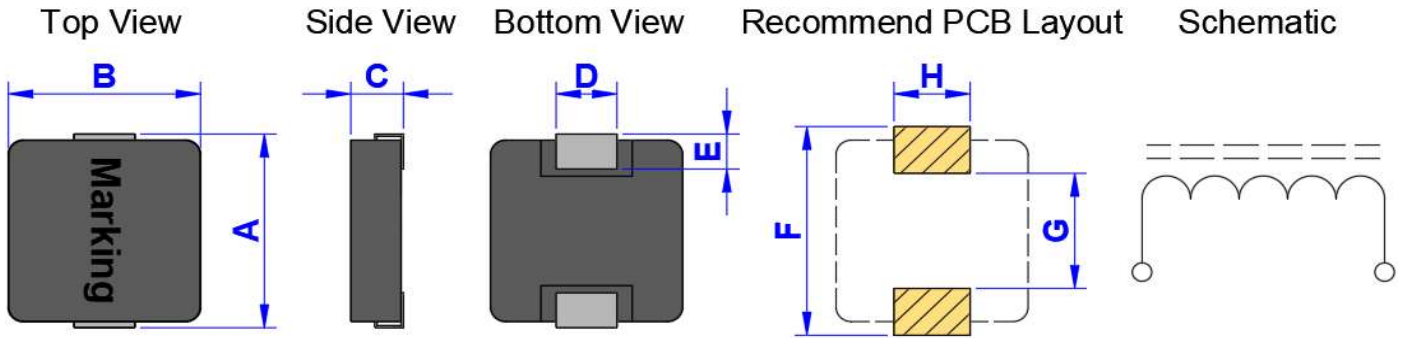

Marking : Inductance code

A(+/-0.6)	B(+/-0.3)	C(Max.)	D(+/-0.5)	E(+/-0.5)	F(Ref.)	G(Ref.)	H(Ref.)
11.0	10.1	4.0	3.0	2.5	13.0	6.0	4.0

Electrical Characteristics :

Part No.	Inductance (uH)	Inductance Tolerance	DCR (mΩ) (Max.)	Isat (Amp) (Typ.)	Irms (Amp) (Typ.)
GSTU1040PA-R22M	0.22	M	0.8	45.0	30.0
GSTU1040PA-R36M	0.36	M	1.2	42.0	27.0
GSTU1040PA-R47M	0.47	M	1.5	32.0	25.0
GSTU1040PA-R56M	0.56	M	1.8	31.0	24.0
GSTU1040PA-R68M	0.68	M	2.0	30.0	23.0
GSTU1040PA-1R0M	1.00	M	3.1	26.0	20.0
GSTU1040PA-1R5M	1.50	M	4.2	22.0	16.0
GSTU1040PA-2R2M	2.20	M	7.0	16.0	14.0
GSTU1040PA-3R3M	3.30	M	13.2	12.0	11.0
GSTU1040PA-4R7M	4.70	M	16.5	12.0	9.0
GSTU1040PA-5R6M	5.60	M	20.0	11.0	7.0
GSTU1040PA-6R8M	6.80	M	25.0	10.0	6.0
GSTU1040PA-8R2M	8.20	M	30.0	9.0	6.0
GSTU1040PA-100M	10.00	M	30.0	7.0	5.5
GSTU1040PA-150M	15.00	M	45.0	6.0	5.25
GSTU1040PA-220M	22.00	M	72.0	5.5	5.0
GSTU1040PA-330M	33.00	M	110.0	5.0	3.2
GSTU1040PA-470M	47.00	M	158.0	3.7	2.8
GSTU1040PA-560M	56.00	M	180.0	3.5	2.6
GSTU1040PA-680M	68.00	M	195.0	2.6	2.5
GSTU1040PA-820M	82.00	M	250.0	2.3	2.2
GSTU1040PA-101M	100.00	M	300.0	2.0	1.5

* Test Condition : @100KHz , 1.0Vrms , 25°C Ambient

* Inductance Tolerance : M = +/-20%

* I_{rms} : Rated Current Loading when temperature rise approximately 40°C.

* I_{sat} : Saturated Current measured at the point of L drop approximately 30%.

* Absolute maximum voltage : 30VDC.

GSTU1040PA-SERIES

Typical Performance Curves :

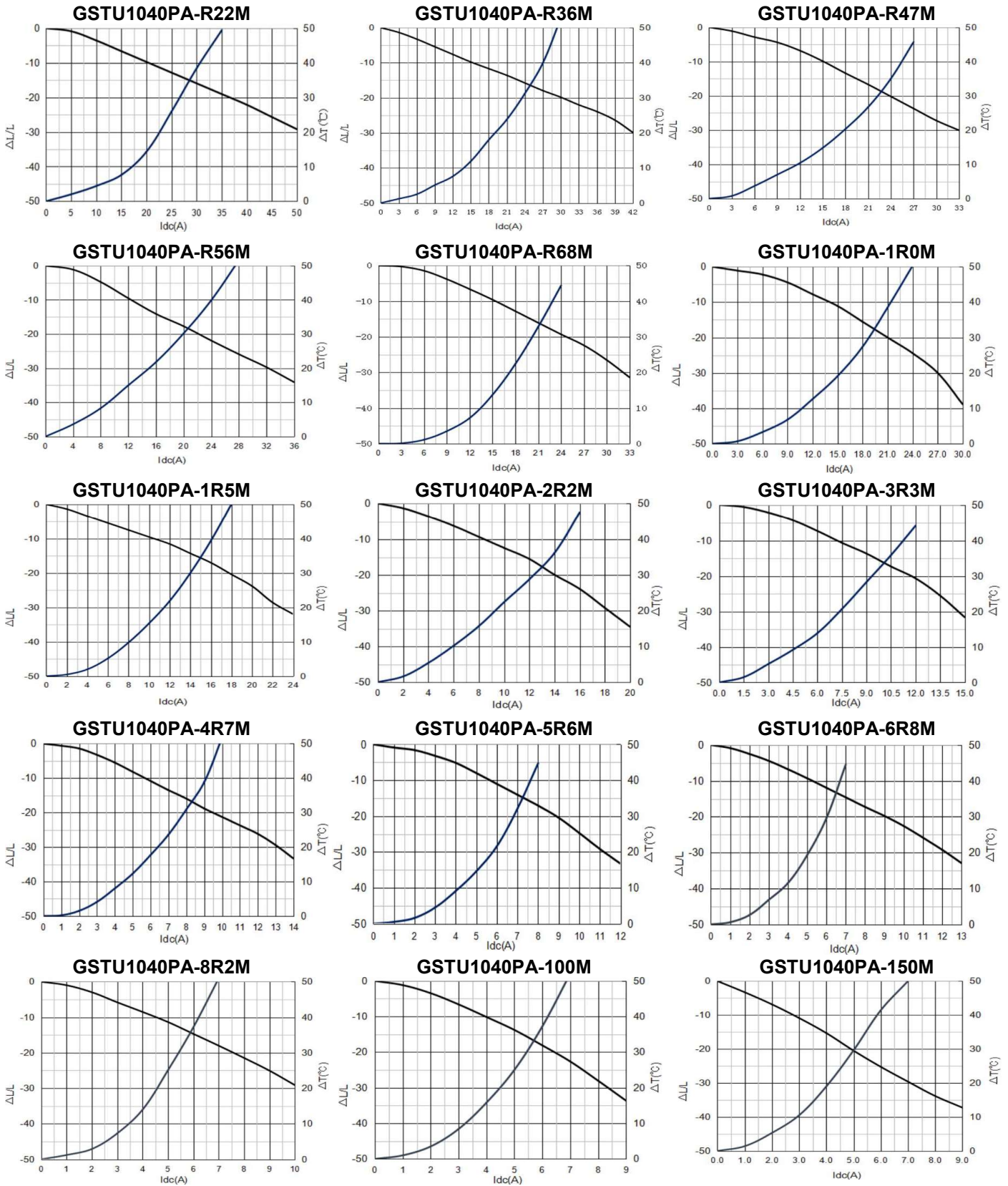

Product Series : GSTU
File Version : GSTU-SERIES
Established Date 2025.03.27
Latest Edit Date : 2025.04.01

Brand : GOTREND
Editor : Yinghui Guo
Description : High Current Inductor
Product Type : Standard Customize

GSTU1040PA-SERIES

Typical Performance Curves :

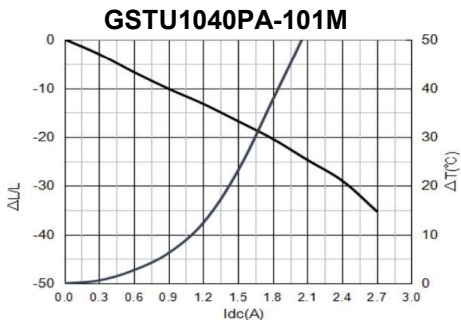
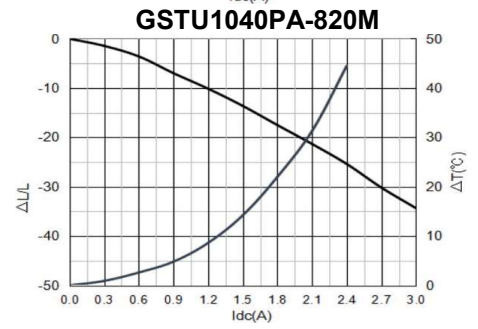
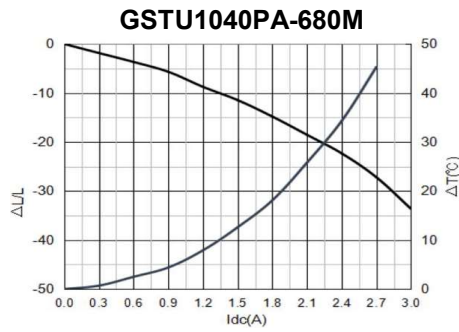
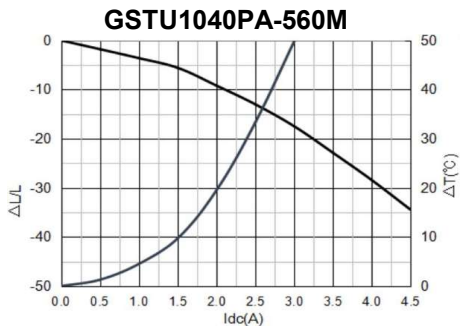
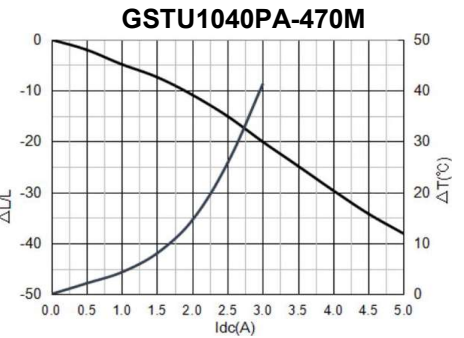
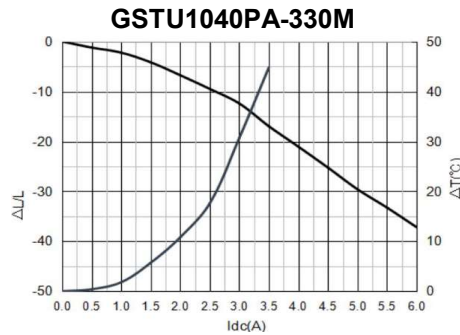
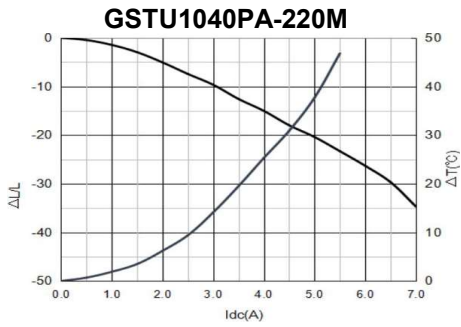

Product Series : GSTU	Brand : GOTREND
File Version : GSTU-SERIES	Editor : Yinghui Guo
Established Date : 2025.03.27	Description : High Current Inductor
Latest Edit Date : 2025.04.01	Product Type : <input checked="" type="checkbox"/> Standard <input type="checkbox"/> Customize

GSTU1050PA-SERIES

Dimension [mm] :

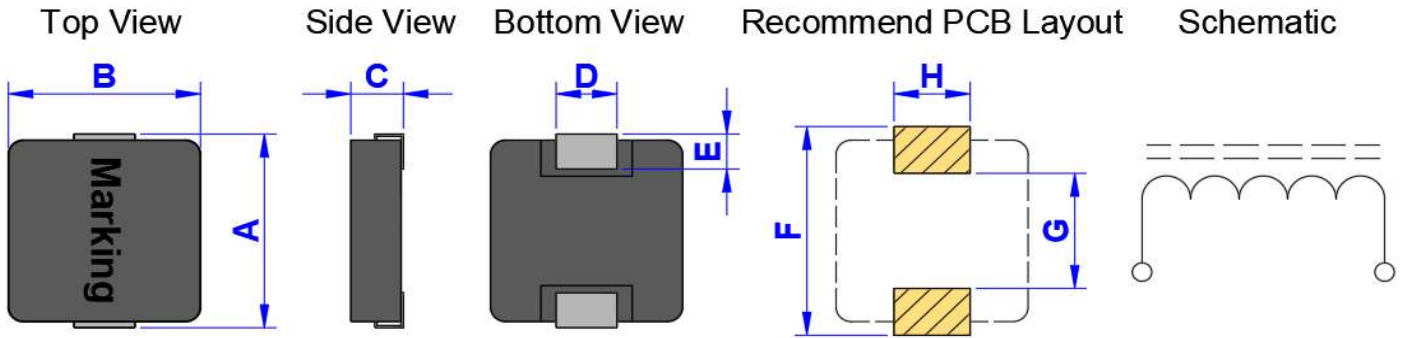

Marking : Inductance code

A(Max.)	B(+/-0.3)	C(Max.)	D(+/-0.5)	E(+/-0.5)	F(Ref.)	G(Ref.)	H(Ref.)
11.6	10.1	5.0	3.0	2.5	13.0	6.0	4.0

Electrical Characteristics :

Part No.	Inductance (uH)	Inductance Tolerance	DCR (mΩ) (Max.)	Isat (Amp) (Typ.)	Irms (Amp) (Typ.)
GSTU1050PA-R33M	0.33	M	0.9	38.0	28.0
GSTU1050PA-R56M	0.56	M	2.0	33.0	25.0
GSTU1050PA-1R0M	1.00	M	3.0	24.0	20.0
GSTU1050PA-1R5M	1.50	M	4.2	23.0	16.0
GSTU1050PA-2R2M	2.20	M	6.5	18.0	12.5
GSTU1050PA-3R3M	3.30	M	11.0	16.0	11.0
GSTU1050PA-4R7M	4.70	M	13.0	14.0	10.0
GSTU1050PA-5R6M	5.60	M	16.5	13.0	9.5
GSTU1050PA-6R8M	6.80	M	18.5	12.0	8.0
GSTU1050PA-8R2M	8.20	M	23.0	11.0	7.5
GSTU1050PA-100M	10.00	M	25.0	9.0	7.0
GSTU1050PA-150M	15.00	M	45.0	7.0	5.5
GSTU1050PA-220M	22.00	M	65.0	6.5	5.5
GSTU1050PA-330M	33.00	M	85.0	5.0	3.5
GSTU1050PA-470M	47.00	M	100.0	3.5	3.2
GSTU1050PA-680M	68.00	M	150.0	3.0	2.8
GSTU1050PA-101M	100.00	M	250.0	2.5	1.5

* Test Condition : @100KHz , 1.0Vrms , 25°C Ambient

* Inductance Tolerance : M = +/-20%

* I_{rms} : Rated Current Loading when temperature rise approximately 40°C.

* I_{sat} : Saturated Current measured at the point of L drop approximately 30%.

* Absolute maximum voltage : 30VDC.

Typical Performance Curves :

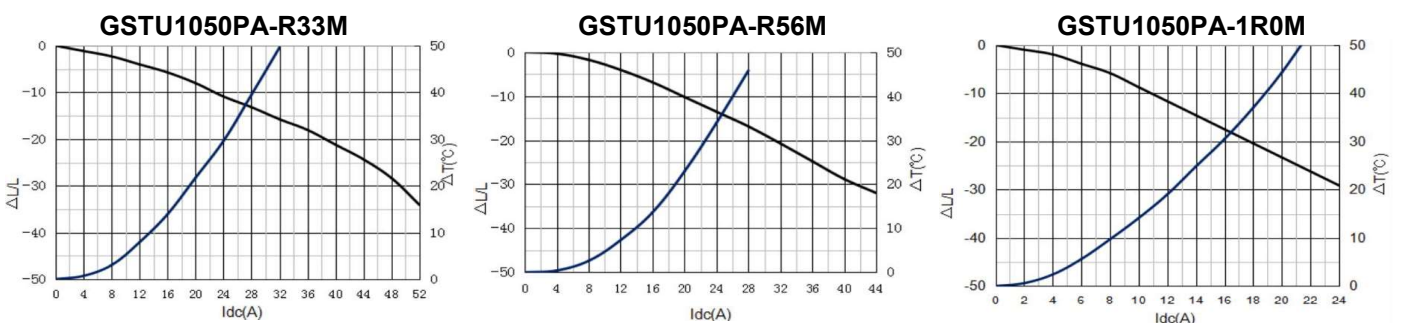

GSTU1050PA-SERIES

Typical Performance Curves :

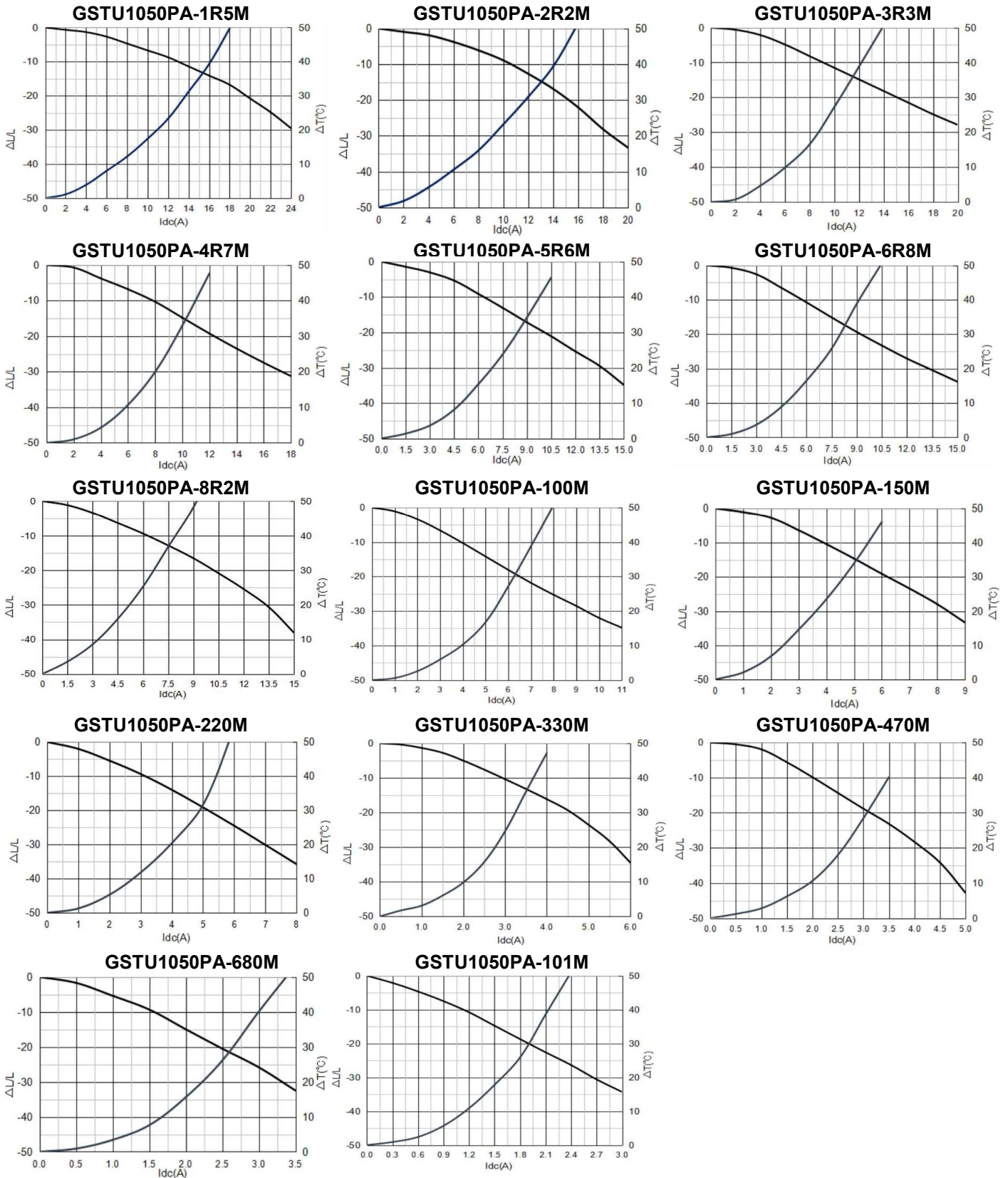

Product Series : GSTU	Brand : GOTREND
File Version : GSTU-SERIES	Editor : Yinghui Guo
Established Date 2025.03.27	Description : High Current Inductor
Latest Edit Date : 2025.04.01	Product Type : <input checked="" type="checkbox"/> Standard <input type="checkbox"/> Customize

GSTU1250PA-SERIES

Dimension [mm] :

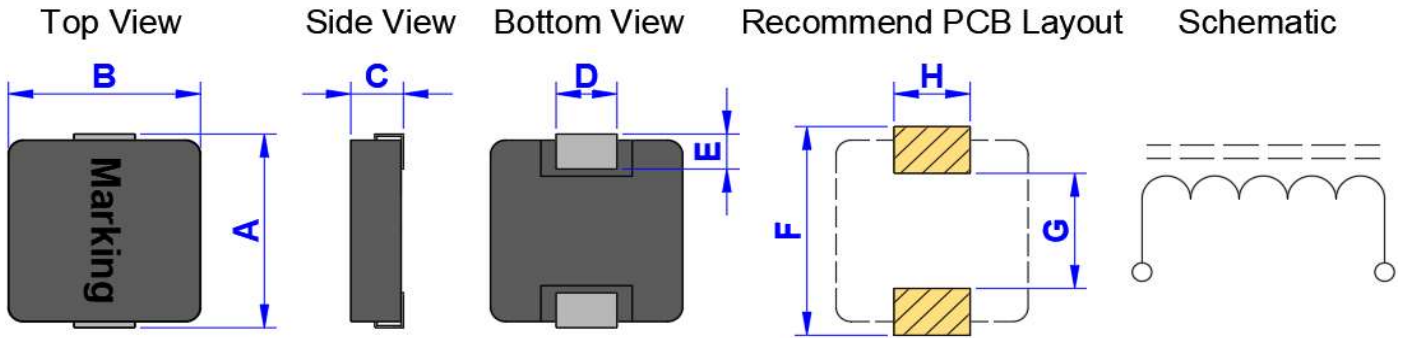

Marking : Inductance code

A(Max.)	B(+/-0.2)	C(Max.)	D(+/-0.5)	E(+/-0.5)	F(Ref.)	G(Ref.)	H(Ref.)
13.8	12.6	5.0	3.7	2.7	14.5	6.5	5.0

Electrical Characteristics :

Part No.	Inductance (uH)	Inductance Tolerance	DCR (mΩ) (Max.)	Isat (Amp) (Typ.)	Irms (Amp) (Typ.)
GSTU1250PA-R47M	0.47	M	1.3	52.0	30.0
GSTU1250PA-R68M	0.68	M	1.55	32.0	24.0
GSTU1250PA-R82M	0.82	M	1.65	30.0	23.0
GSTU1250PA-1R0M	1.00	M	2.5	28.0	22.0
GSTU1250PA-1R5M	1.50	M	3.0	24.0	15.0
GSTU1250PA-2R2M	2.20	M	6.0	23.0	13.0
GSTU1250PA-3R3M	3.30	M	8.0	20.5	12.0
GSTU1250PA-4R7M	4.70	M	11.5	16.0	11.0
GSTU1250PA-6R8M	6.80	M	22.0	14.0	9.0
GSTU1250PA-8R2M	8.20	M	27.0	12.0	7.5
GSTU1250PA-100M	10.00	M	35.0	11.0	7.0
GSTU1250PA-150M	15.00	M	36.0	9.2	6.0
GSTU1250PA-220M	22.00	M	60.0	7.0	5.5
GSTU1250PA-330M	33.00	M	80.0	5.5	5.0
GSTU1250PA-470M	47.00	M	110.0	4.5	4.0
GSTU1250PA-680M	68.00	M	160.0	4.0	3.0
GSTU1250PA-101M	100.00	M	270.0	3.0	2.0

- * **Test Condition :** @100KHz , 1.0Vrms , 25°C Ambient
- * **Inductance Tolerance :** M = +/-20%
- * **Irms :** Rated Current Loading when temperature rise approximately 40°C.
- * **Isat :** Saturated Current measured at the point of L drop approximately 30%.
- * **Absolute maximum voltage :** 30VDC.

Typical Performance Curves :

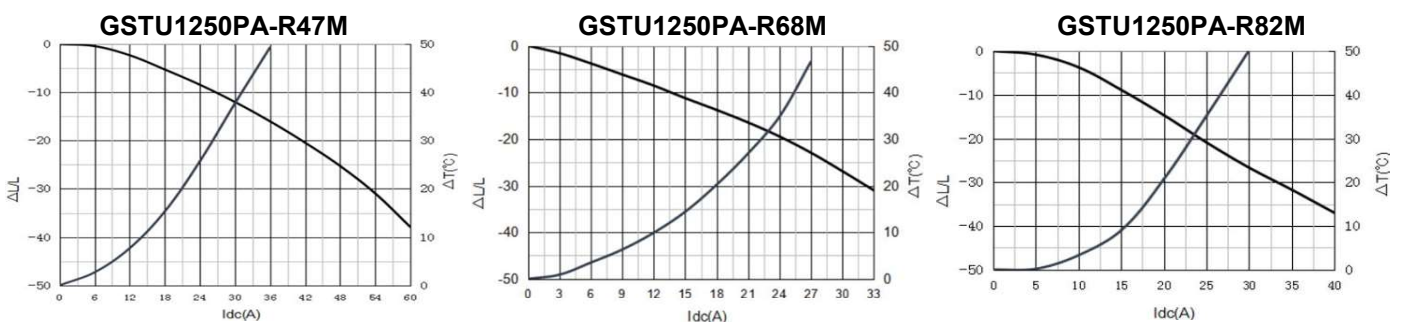

Product Series : GSTU
File Version : GSTU-SERIES
Established Date 2025.03.27
Latest Edit Date : 2025.04.01

Brand : GOTREND
Editor : Yinghui Guo
Description : High Current Inductor
Product Type : Standard Customize

GSTU1250PA-SERIES

Typical Performance Curves :

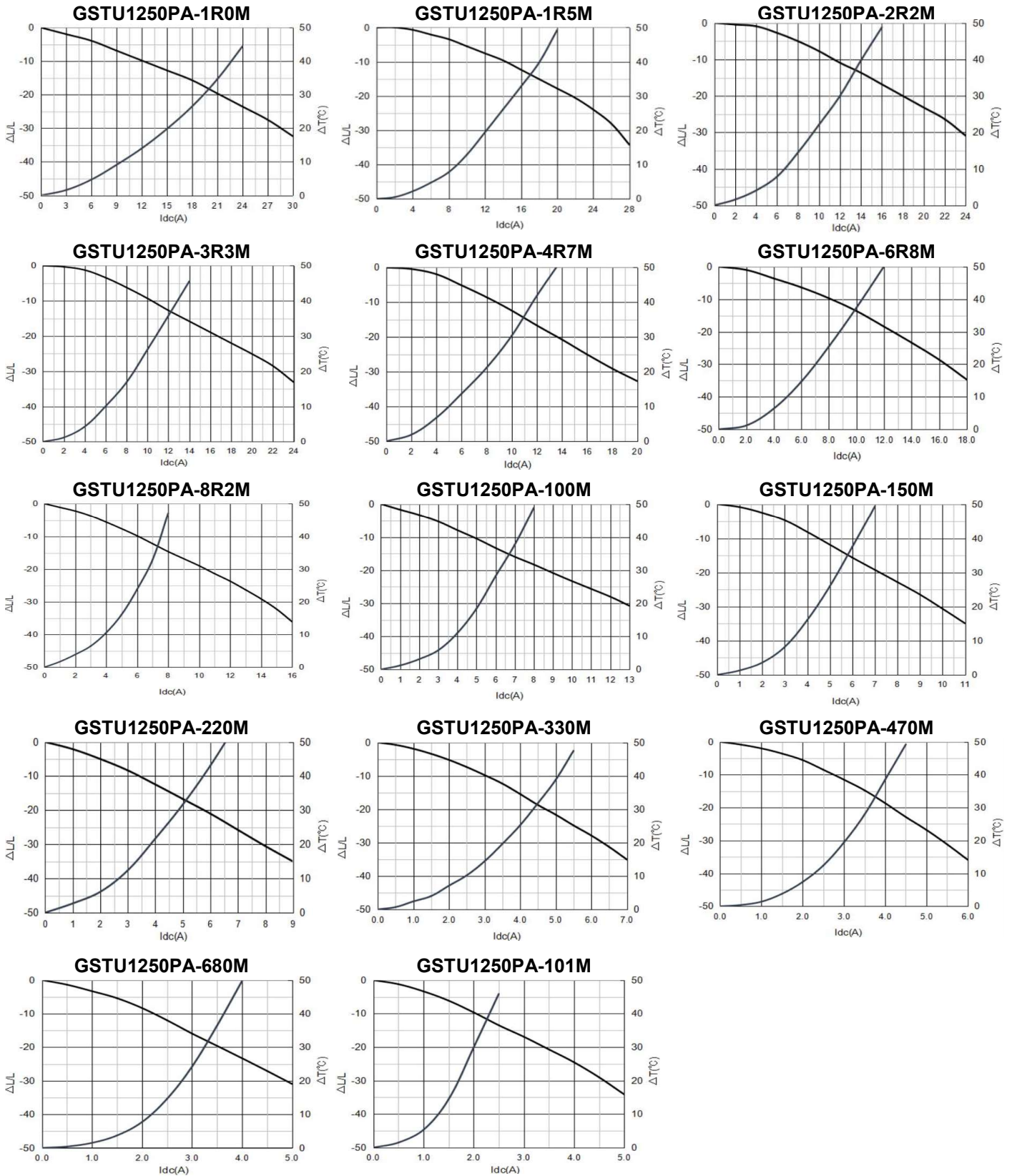

Product Series : GSTU	Brand : GOTREND
File Version : GSTU-SERIES	Editor : Yinghui Guo
Established Date : 2025.03.27	Description : High Current Inductor
Latest Edit Date : 2025.04.01	Product Type : <input checked="" type="checkbox"/> Standard <input type="checkbox"/> Customize

GSTU1260PA-SERIES

Dimension [mm] :

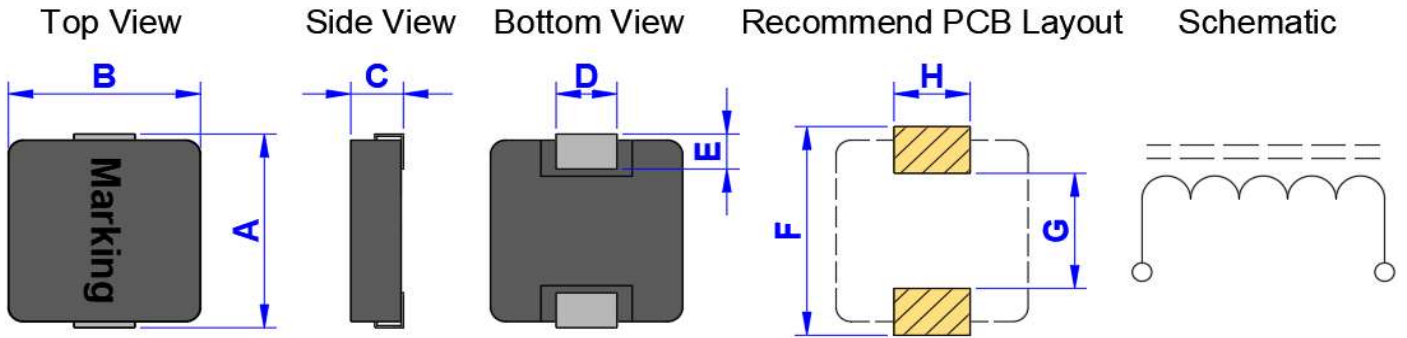

Marking : Inductance code

A(Max.)	B(+/-0.2)	C(Max.)	D(+/-0.5)	E(+/-0.5)	F(Ref.)	G(Ref.)	H(Ref.)
13.8	12.6	6.0	3.7	2.7	14.5	6.5	5.0

Electrical Characteristics :

Part No.	Inductance (uH)	Inductance Tolerance	DCR (mΩ) (Max.)	Isat (Amp) (Typ.)	Irms (Amp) (Typ.)
GSTU1260PA-4R7M	4.70	M	11.0	20.0	12.0
GSTU1260PA-100M	10.00	M	20.7	12.5	10.0
GSTU1260PA-150M	15.00	M	32.0	9.0	6.0
GSTU1260PA-220M	22.00	M	39.5	7.5	5.0
GSTU1260PA-330M	33.00	M	75.0	6.0	4.0
GSTU1260PA-470M	47.00	M	90.0	5.5	3.5
GSTU1260PA-560M	56.00	M	125.0	5.2	3.3
GSTU1260PA-680M	68.00	M	134.0	5.0	3.2
GSTU1260PA-820M	82.00	M	170.0	4.5	3.0
GSTU1260PA-101M	100.00	M	210.0	4.0	2.3

* Test Condition : @100KHz , 1.0Vrms , 25°C Ambient

* Inductance Tolerance : M = +/-20%

* I_{rms} : Rated Current Loading when temperature rise approximately 40°C.

* Isat : Saturated Current measured at the point of L drop approximately 30%.

* Absolute maximum voltage : 30VDC.

Typical Performance Curves :

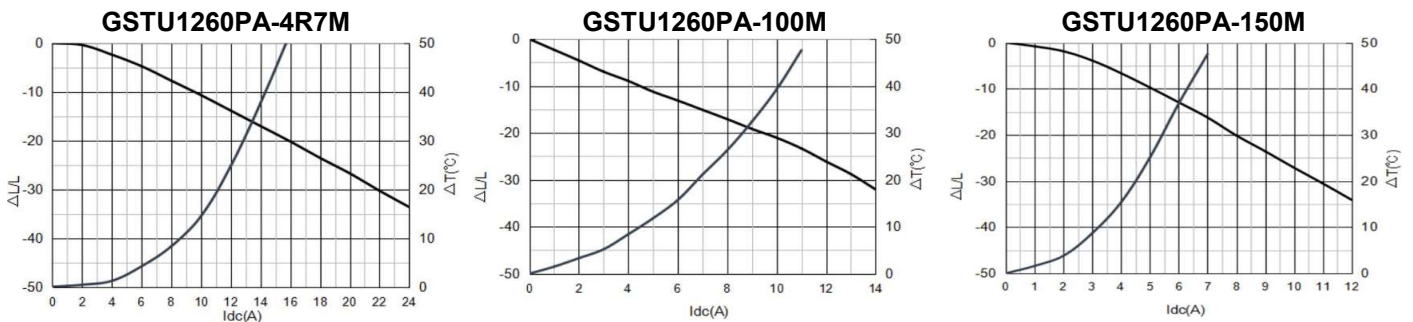

GSTU1260PA-SERIES

Typical Performance Curves :

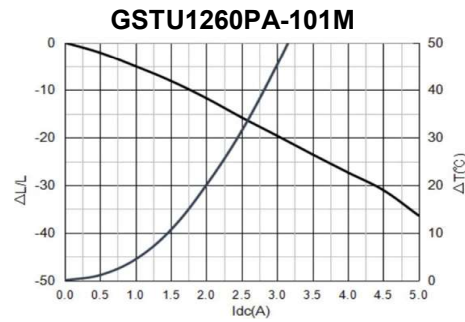
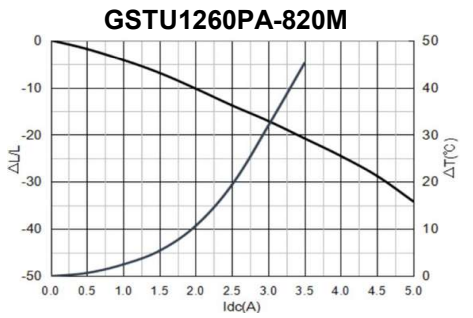
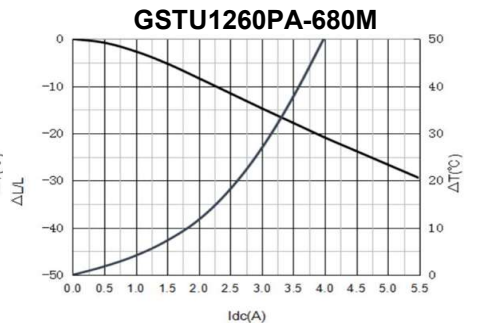
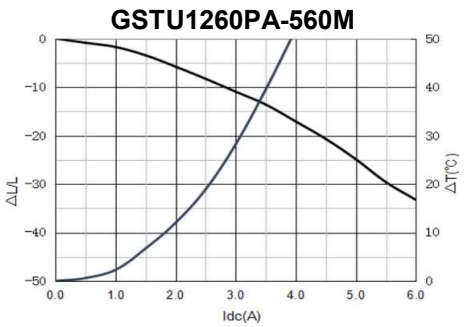
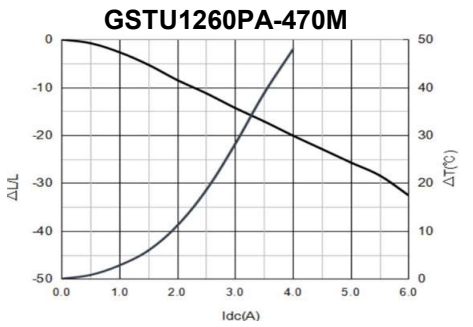
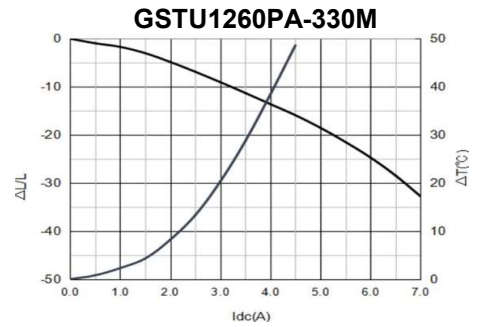
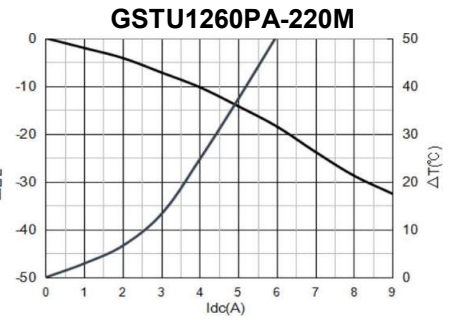
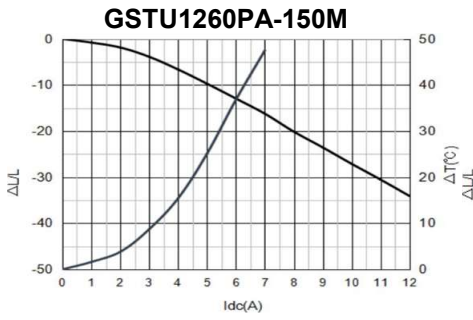

Product Series : GSTU	Brand : GOTREND
File Version : GSTU-SERIES	Editor : Yinghui Guo
Established Date 2025.03.27	Description : High Current Inductor
Latest Edit Date : 2025.04.01	Product Type : <input checked="" type="checkbox"/> Standard <input type="checkbox"/> Customize

GSTU1265PA-SERIES

Dimension [mm] :

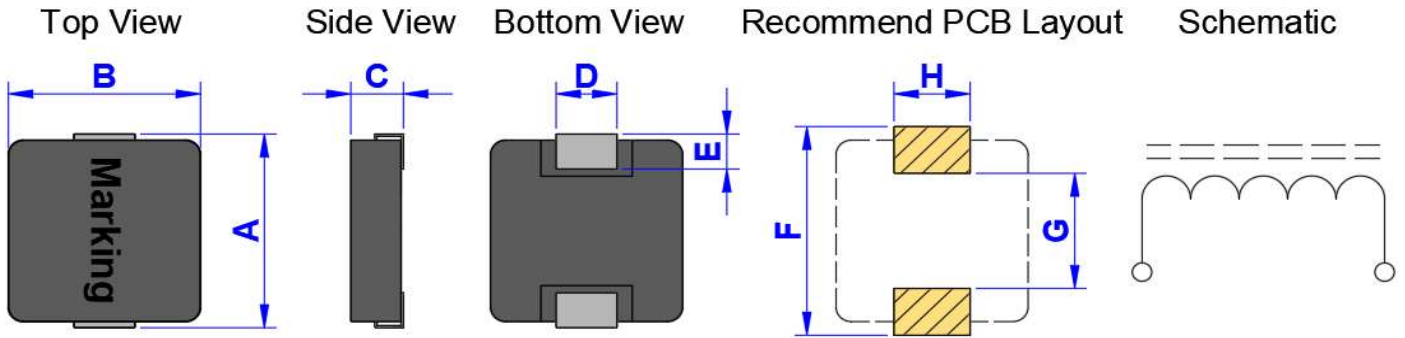

Marking : Inductance code

A(Max.)	B(+/-0.2)	C(Max.)	D(+/-0.5)	E(+/-0.5)	F(Ref.)	G(Ref.)	H(Ref.)
13.8	12.6	6.5	3.7	2.7	14.5	6.5	5.0

Electrical Characteristics :

Part No.	Inductance (uH)	Inductance Tolerance	DCR (mΩ) (Max.)	Isat (Amp) (Typ.)	Irms (Amp) (Typ.)
GSTU1265PA-R47M	0.47	M	1.2	60.0	30.0
GSTU1265PA-1R0M	1.00	M	2.0	36.0	25.0
GSTU1265PA-1R5M	1.50	M	2.5	30.0	20.0
GSTU1265PA-2R2M	2.20	M	4.2	28.0	15.0
GSTU1265PA-3R3M	3.30	M	6.8	25.0	13.0
GSTU1265PA-4R7M	4.70	M	10.0	21.0	12.0
GSTU1265PA-5R6M	5.60	M	13.0	18.0	11.5
GSTU1265PA-6R8M	6.80	M	15.0	16.0	11.0
GSTU1265PA-100M	10.00	M	20.0	15.0	9.0
GSTU1265PA-150M	15.00	M	30.0	10.5	7.0
GSTU1265PA-220M	22.00	M	44.0	7.5	5.8
GSTU1265PA-270M	27.00	M	50.0	7.0	5.6
GSTU1265PA-330M	33.00	M	60.0	6.5	5.5
GSTU1265PA-470M	47.00	M	80.0	6.0	4.5
GSTU1265PA-680M	68.00	M	130.0	5.0	3.5
GSTU1265PA-101M	100.00	M	220.0	4.5	2.5

* Test Condition : @100KHz , 1.0Vrms , 25°C Ambient

* Inductance Tolerance : M = +/-20%

* I_{rms} : Rated Current Loading when temperature rise approximately 40°C.

* I_{sat} : Saturated Current measured at the point of L drop approximately 30%.

* Absolute maximum voltage : 30VDC.

Typical Performance Curves :

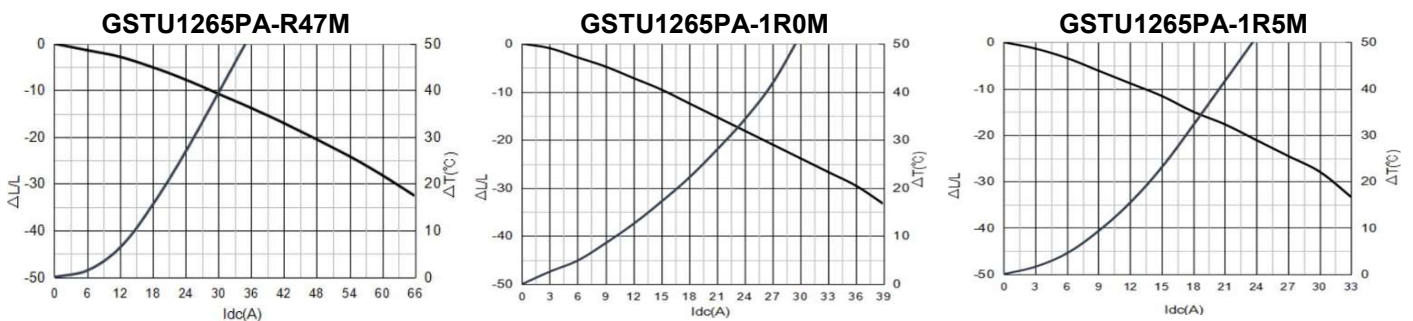

GSTU1265PA-SERIES

Typical Performance Curves :

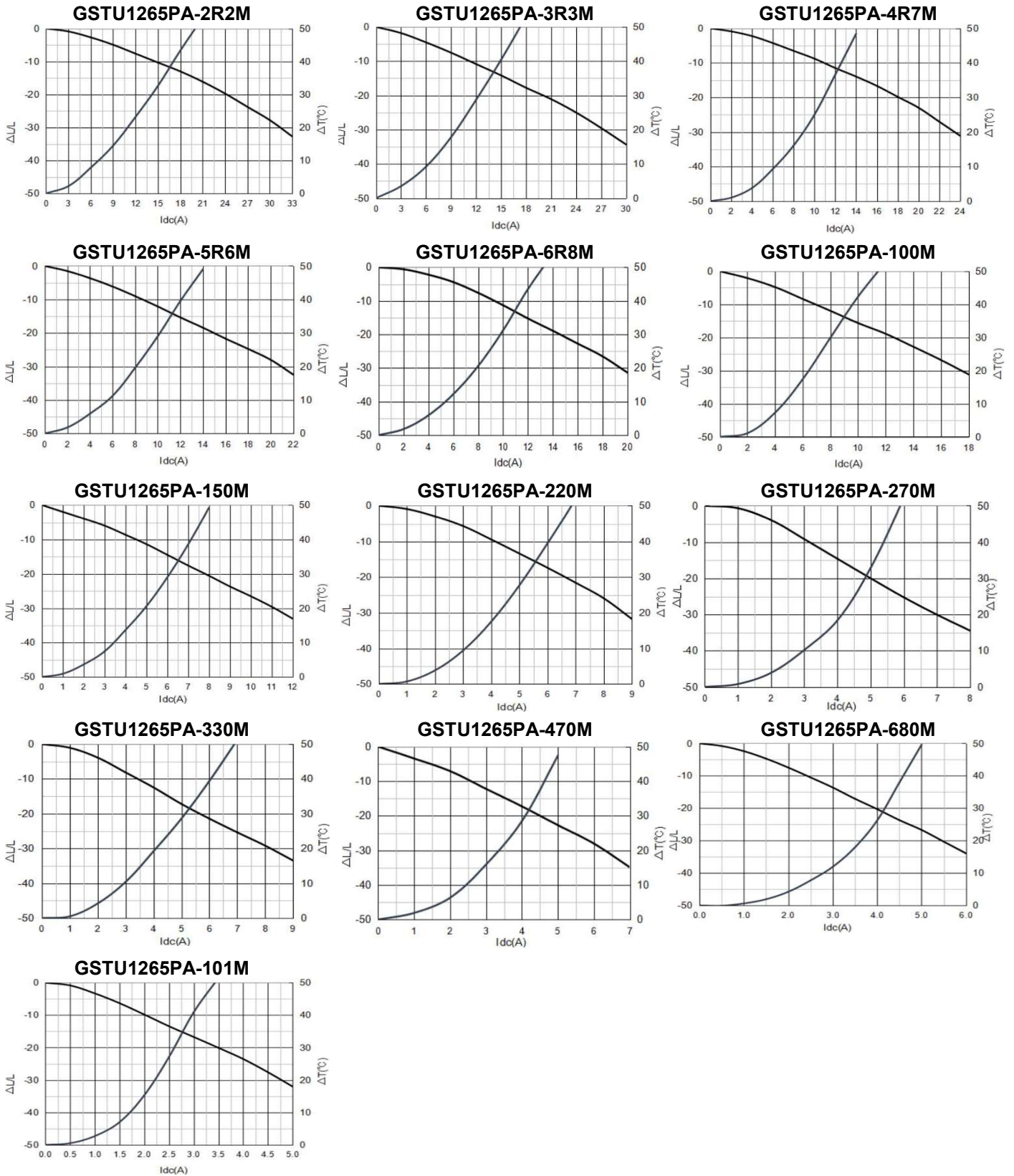

Product Series :	GSTU	Brand :	GOTREND
File Version :	GSTU-SERIES	Editor :	Yinghui Guo
Established Date	2025.03.27	Description :	High Current Inductor
Latest Edit Date :	2025.04.01	Product Type :	<input checked="" type="checkbox"/> Standard <input type="checkbox"/> Customize

Care note :

Care note for Use :

(1) Storage Condition :

Temperature 25 to 35 °C , Humidity 45 to 60% RH

(2) Use Temperature :

- a. Minimum Temperature : -40 °C Ambient temperature of this product.
- b. Maximum Temperature : +125 °C The value of temperature including ambient and temperature rise of this product.
- c. Reliability test temperature range from -40 ~ +125 °C
- d. However, this is not meant as temperature grade guarantee for UL.

(3) Model :

When this product was used in a similar or as new product to the original one, sometimes it might be unable to satisfy the specifications due to difference in condition of usage.

(4) Drop :

If this product suffered mechanical stress such as drop, characteristics may become poor (due to damage on coil / bobbin / ferrite ... etc.)

Never use such stressed product.

Care note for Safety :

(1) Provision to Abnormal Condition :

This product itself does not have any protective function in abnormal condition such as overload, short-circuit and open-circuit conditions, etc.

Therefore, it shall be confirmed from the end product that there is no risk of smoking, fire, dielectric withstand voltage insulation resistance, etc. in abnormal conditions to provide protective devices and /or protection circuit in the end product.

(2) Temperature Rise :

Temperature rise on this product depends on the installation condition on end products.

It shall be confirmed on the actual end product that temperature rise of this product is within the specified temperature class limit.

(3) Dielectric Strength :

Dielectric withstanding test with higher voltage than specific value will damage insulating material and shorten its life.

(4) Water :

This product must not be used in wet condition resulted from water, coffee or any liquid contact because insulation strength becomes very low under such condition.

(5) Potting :

If this product is potted in some compound, coating material of magnet wire might be occasionally damaged. Please ask us if you intend to pot this product.

(6) Detergent :

Please consult our company immediately once under such circumstances because product reliability confirmation etc. is needed when this product come in contact with these chemicals.

Product Series : GSTU	Brand : GOTREND
File Version : GSTU-SERIES	Editor : Yinghui Guo
Established Date 2025.03.27	Description : High Current Inductor
Latest Edit Date : 2025.04.01	Product Type : <input checked="" type="checkbox"/> Standard <input type="checkbox"/> Customize

Reliability :

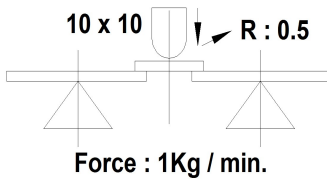
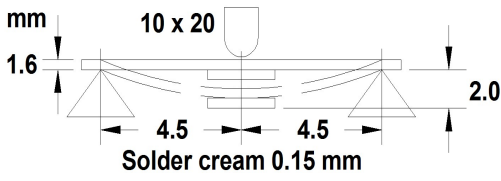
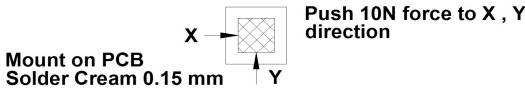
SN	Test Item	Test Condition	Specification		
1	Dimension	Actual Size ...	Meet Spec		
2	Thermal Shock (Temperature Cycle)	Temperature : -40 ~ +125 °C kept stabilized for 30 min. each Cycle : 100 Cycles (power off)	Elec. no variation Appearance no deformation		
3	Humidity Resistance	Humidity : 90% ~ 95% RH Temperature : 60 ± 2 °C, Test Time : 96 ± 2 Hours	Elec. no variation Appearance no deformation		
4	High Temperature	Temperature : 125 ± 2 °C Testing Time : 96 ± 2 Hours	Elec. no variation Appearance no deformation		
5	Low Temperature	Temperature : -40 ± 2 °C Time : 96 ± 2 Hours	Elec. no variation Appearance no deformation		
6	Temperature and Humidity Cycle	Temperature	Humidity	Time	Elec. no variation Appearance no deformation
		25 °C	90% ~ 95% RH	3.0 Hr	
		55 °C	95% ~ 96% RH	5.0 Hr	
		25 °C	90% ~ 95% RH	3.0 Hr	
		Cycle : 20 Cycles			
7	Vibration	Frequency : 10Hz ~ 55Hz, Amplitude : 1.5 mm Direction : X, Y, Z, Time : 2 Hours each	Elec. no variation Appearance no deformation		
8	Solderability	Go through real SMT IR-Reflow The profile like our suggest profile. Preheat : 160 ± 10 °C (90 sec) Peak : 245 ± 5 °C Peak Time : 50 Sec. / up 217 °C	Elec. no variation Appearance no deformation		
9	Soldering Heat Resistance	Preheat : 160 ± 10 °C (90 sec) Solder : Sn / Ag / Cu (Pb Free) Solder Temp. : 260 ± 5 °C, Time : 3 ± 1 seconds	Elec. no variation Appearance no deformation		
10	Iron Solder Heat Resistance	Solder Temp. : 350 ± 5 °C Flux : Rosin, Time : 3 ± 1 seconds	Elec. no variation Appearance no deformation		
11	Bending Strength	Unit : mm  Force : 1Kg / min.	Elec. no variation Appearance no deformation		
12	Flexure Strength	Unit : mm  Solder cream 0.15 mm	Elec. no variation Appearance no deformation		
13	Terminal Strength	 Mount on PCB Solder Cream 0.15 mm Push 10N force to X, Y direction	Elec. no variation Appearance no deformation		
14	Load life	Temperature : 25 ± 3 °C Load : Allowed DC Current, Test Time : 96 ± 2 Hours	Elec. no variation Appearance no deformation		

Product Series : GSTU
File Version : GSTU-SERIES
Established Date 2025.03.27
Latest Edit Date : 1900/1/1

Brand : GOTREND
Editor : Yinghui Guo
Description : High Current Inductor
Product Type : Standard Customize

Packaging Information :

Tape Dimension (mm)

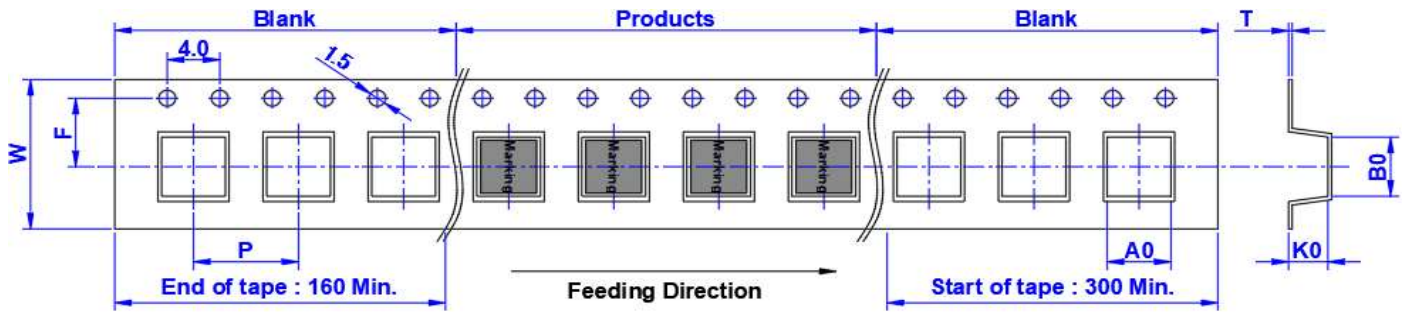

SIZE/mm	W	P	A0	B0	K0	T	F
4020	12.0	8.0	4.30	4.90	2.25	0.30	5.50
5018	12.0	8.0	5.50	5.60	2.20	0.35	5.50
5020	12.0	8.0	5.50	5.60	2.20	0.35	5.50
5030	12.0	8.0	5.50	5.60	3.30	0.35	5.50
6018	16.0	12.0	6.85	7.70	2.10	0.35	7.50
6020	16.0	12.0	6.85	7.70	2.30	0.35	7.50
6024	16.0	12.0	6.85	7.70	2.60	0.35	7.50
6030	16.0	12.0	6.85	7.75	3.30	0.35	7.50
6040	16.0	12.0	7.00	7.90	4.30	0.35	7.50
6050	16.0	12.0	6.85	7.70	5.20	0.35	7.50
8040	16.0	12.0	8.35	8.90	4.20	0.40	7.50
8050	16.0	12.0	8.35	9.10	5.20	0.40	7.50
1040	24.0	16.0	10.55	11.95	4.10	0.40	11.50
1050	24.0	16.0	10.50	11.95	5.20	0.40	11.50
1250	24.0	16.0	12.90	14.80	5.20	0.40	11.50
1260	24.0	16.0	12.90	14.80	6.70	0.40	11.50
1265	24.0	16.0	12.90	14.80	6.70	0.40	11.50

Product Series : GSTU
File Version : GSTU-SERIES
Established Date 2025.03.27
Latest Edit Date : 1900/1/1

Brand : GOTREND
Editor : Yinghui Guo
Description : High Current Inductor
Product Type : Standard Customize

Packaging Information :

Reel Dimension (mm)

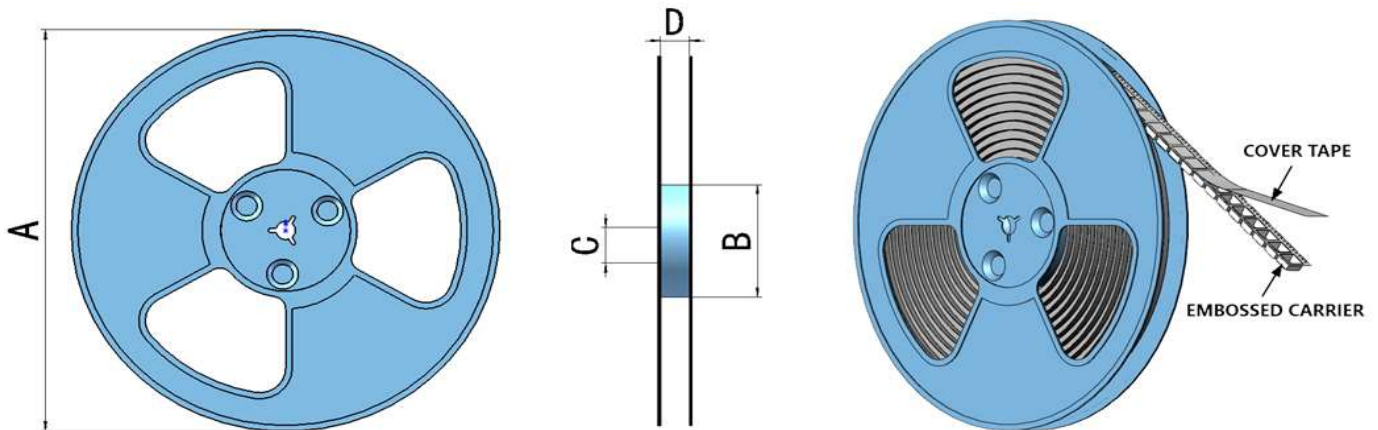

SIZE/mm	Reel Size	A	B	C	D	QTY / Reel
4020	13" × 12 mm	330	100	13	12.5	3,000 PCS
5018	13" × 12 mm	330	100	13	12.5	3,000 PCS
5020	13" × 12 mm	330	100	13	12.5	3,000 PCS
5030	13" × 12 mm	330	100	13	12.5	2,000 PCS
6018	13" × 16 mm	330	100	13	16.5	2,000 PCS
6020	13" × 16 mm	330	100	13	16.5	2,000 PCS
6024	13" × 16 mm	330	100	13	16.5	1,500 PCS
6030	13" × 16 mm	330	100	13	16.5	1,000 PCS
6040	13" × 16 mm	330	100	13	16.5	1,000 PCS
6050	13" × 16 mm	330	100	13	16.5	1,000 PCS
8040	13" × 16 mm	330	100	13	16.5	1,000 PCS
8050	13" × 16 mm	330	100	13	16.5	1,000 PCS
1040	13" × 24 mm	330	100	13	24.5	500 PCS
1050	13" × 24 mm	330	100	13	24.5	500 PCS
1250	13" × 24 mm	330	100	13	24.5	500 PCS
1260	13" × 24 mm	330	100	13	24.5	500 PCS
1265	13" × 24 mm	330	100	13	24.5	500 PCS

Tearing Off Force

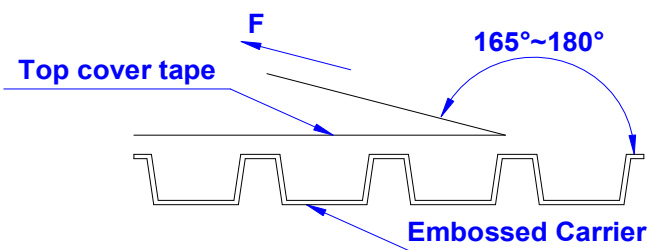

The force for tearing off cover tape is 10 to 130 grams in the arrow direction under the following conditions (referenced ANSI / EIA - 481 - D - 2008 of 4.11 standard).

Room Temp. (°C)	Room Humidity (%)	Room Atm. (hPa)	Tearing Speed (mm / min)
5 ~ 35	45 ~ 85	860 ~ 1060	300

Product Series : GSTU
 File Version : GSTU-SERIES
 Established Date : 2025.03.27
 Latest Edit Date : 1900/1/1

Brand : GOTREND
 Editor : Yinghui Guo
 Description : High Current Inductor
 Product Type : Standard Customize

Packaging Information :

Box Package

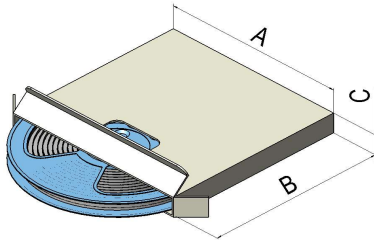

13" Small Box

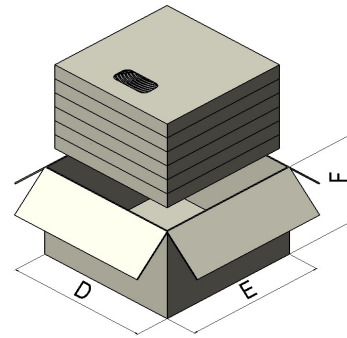

13" Large Box

SIZE/mm	Reels size	A	B	C	Large Box	D	E	F	Reels in Small Box (QTY)	Small Box in Large Box(QTY)
4020	13"	335	335	40	13"	350	350	220	2(6,000)	5(30,000)
5018	13"	335	335	40	13"	350	350	220	2(6,000)	5(30,000)
5020	13"	335	335	40	13"	350	350	220	2(6,000)	5(30,000)
5030	13"	335	335	40	13"	350	350	220	2(4,000)	5(20,000)
6018	13"	335	335	23	13"	350	350	220	1(2,000)	7(14,000)
6020	13"	335	335	23	13"	350	350	220	1(2,000)	7(14,000)
6024	13"	335	335	23	13"	350	350	220	1(1,500)	7(10,500)
6030	13"	335	335	23	13"	350	350	220	1(1,000)	7(7,000)
6040	13"	335	335	23	13"	350	350	220	1(1,000)	7(7,000)
6050	13"	335	335	23	13"	350	350	220	1(1,000)	7(7,000)
8040	13"	335	335	23	13"	350	350	220	1(1,000)	7(7,000)
8050	13"	335	335	23	13"	350	350	220	1(1,000)	7(7,000)
1040	13"	335	335	40	13"	350	350	220	1(500)	5(2,500)
1050	13"	335	335	40	13"	350	350	220	1(500)	5(2,500)
1250	13"	335	335	40	13"	350	350	220	1(500)	5(2,500)
1260	13"	335	335	40	13"	350	350	220	1(500)	5(2,500)
1265	13"	335	335	40	13"	350	350	220	1(500)	5(2,500)